



ENRON operates networks throughout the world to develop and enhance energy and broadband communication services. Networks, unlike vertically integrated business structures, facilitate the flow of information and expertise. We can spot market signals faster and respond more quickly. Networks empower individuals, freeing them to craft innovative and substantive solutions to customer problems. Networks are the foundation of our knowledge-based businesses, and they provide exceptional returns and value for our shareholders.

On the front and back covers: Five of the 13 Chairman's Roundtable members of 1999 and the winner of the 1999 Chairman's Award, Bobbye Brown (far left on front cover). The Chairman's Award, which includes the selection of Chairman's Roundtable members, is an annual, employee-driven program that recognizes Enron's everyday heroes—people who make a difference by living our values of communication, integrity, respect and excellence in everything they do.

## CONTENTS

- 1 FINANCIAL HIGHLIGHTS
- 2 LETTER TO SHAREHOLDERS
- 6 WHOLESALE ENERGY BUSINESS
- 14 ENRON BROADBAND SERVICES
- 18 RETAIL ENERGY SERVICES
- 22 TRANSPORTATION AND DISTRIBUTION
- 26 A GLOBAL LOOK AT ENRON (MAPS)
- 30 FINANCIAL REVIEW
- 63 ENRON OFFICES
- 64 BOARD OF DIRECTORS
- 66 EXECUTIVE COMMITTEE
- 66 SHAREHOLDER INFORMATION
- 67 OUR VALUES

## FINANCIAL HIGHLIGHTS

(Unaudited: in millions, except per share data)

	1999	1998	1997	1996	1995
Revenues	\$ 40,112	\$31,260	\$20,273	\$13,289	\$ 9,189
Net income:					
Operating results	\$ 957	\$ 698	\$ 515	\$ 493	\$ 489
Items impacting comparability	(64)	5	(410)	91	31
<b>Total</b>	<b>\$ 893</b>	<b>\$ 703</b>	<b>\$ 105</b>	<b>\$ 584</b>	<b>\$ 520</b>
Earnings per diluted common share:					
Operating results	\$ 1.18	\$ 1.00	\$ 0.87	\$ 0.91	\$ 0.91
Items impacting comparability	(0.08)	0.01	(0.71)	0.17	0.06
<b>Total</b>	<b>\$ 1.10</b>	<b>\$ 1.01</b>	<b>\$ 0.16</b>	<b>\$ 1.08</b>	<b>\$ 0.97</b>
Dividends paid per common share	\$ 0.50	0.48	0.46	0.43	0.41
Total assets	\$33,381	29,350	22,552	16,137	13,239
Capital expenditures and equity investments	\$ 3,085	3,564	2,092	1,483	947
NYSE price range					
High	44 <sup>7</sup> / <sub>16</sub>	29 <sup>3</sup> / <sub>16</sub>	22 <sup>9</sup> / <sub>16</sub>	23 <sup>3</sup> / <sub>16</sub>	19 <sup>11</sup> / <sub>16</sub>
Low	28 <sup>3</sup> / <sub>16</sub>	19 <sup>1</sup> / <sub>16</sub>	17 <sup>1</sup> / <sub>2</sub>	17 <sup>5</sup> / <sub>16</sub>	14
Close December 31	44 <sup>3</sup> / <sub>16</sub>	28 <sup>17</sup> / <sub>162</sub>	20 <sup>25</sup> / <sub>162</sub>	21 <sup>5</sup> / <sub>16</sub>	19 <sup>5</sup> / <sub>16</sub>

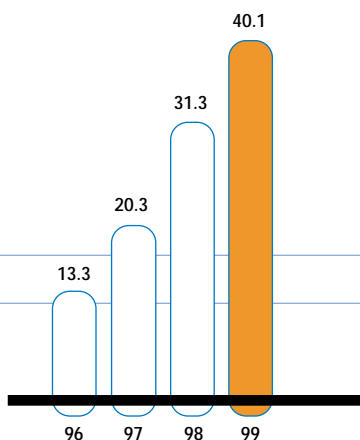

REVENUES  
(\$ in billions)

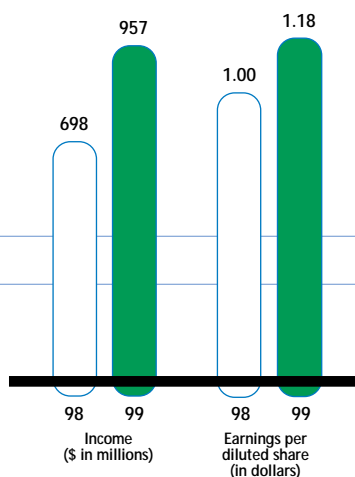

OPERATING RESULTS

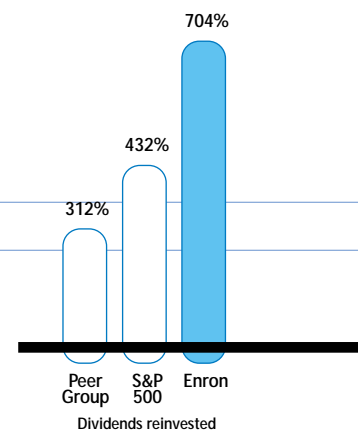

TEN-YEAR CUMULATIVE  
TOTAL RETURN  
(through December 31, 1999)

## TO OUR SHAREHOLDERS

Enron is moving so fast that sometimes others have trouble defining us. But we know who we are. We are clearly a knowledge-based company, and the skills and resources we used to transform the energy business are proving to be equally valuable in other businesses. Yes, we will remain the world's leading energy company, but we also will use our skills and talents to gain leadership in fields where the right opportunities beckon.

In 1999 we witnessed an acceleration of Enron's staggering pace of commercial innovation, driven by a quest to restructure inefficient markets, break down barriers and provide customers with what they want and need, when they want and need it. We reported another round of impressive financial and operating results. In 1999 revenue increased 28 percent to \$40 billion, and net income before non-recurring items increased 37 percent to reach \$957 million. Our total return to shareholders of 58 percent was eight times higher than our peer group and almost triple the S&P 500 return.

We believe the future will be even more rewarding. We remain the world's leader in wholesale and retail energy services. Our new broadband subsidiary, Enron Broadband Services, is redefining Internet performance by designing and supplying a full range of premium broadband delivery services. The value of products bought and sold on our new eCommerce platform, EnronOnline™ is destined to exceed the value transacted on any current eCommerce web site. To reap greater growth and value in our traditional energy businesses without a parallel increase in capital spending, we have evolved into a series of global networks—each of which is a leader in its specific region. These networks work our physical assets harder and drive more high-return products and services into the market. We believe that our broad networks will give us unbeatable scale and scope in every business in every region in which we operate.

Networks now serve as our business platform. They increase our agility and speed our response. They produce more and better options for customers. And they increase returns.

### THE NEW ECONOMY

We are participating in a New Economy, and the rules have changed dramatically. What you own is not as important as what you know. Hard-wired businesses, such as energy and communications, have turned into knowledge-based industries that place a premium on creativity. Enron has been and always will be the consummate innovator because of our extraordinary people. It is our intellectual capital—not only our physical assets—that makes us Enron. Move our assets to another company, and the results would be markedly different.

When you define a New Economy company, you define Enron. A New Economy enterprise exhibits four traits:

1. *Its strength comes from knowledge, not just from physical assets.*

Enron has become a pre-eminent energy and communications company not only by building and controlling physical

assets, but also from our unique ability to add knowledge to those assets to create a market-making network, such as our electricity and natural gas markets in North America and Europe.

2. *A New Economy player must operate globally—effortlessly transferring ideas, people and services from region to region.*

Our knowledge and expertise crisscross the globe. What we've learned about natural gas pipelines in the United States helps us build new natural gas markets in South America and India. Our knowledge of optimizing capacity in energy networks will allow us to revolutionize the bandwidth market.

3. *New Economy companies understand that constant innovation is their only defense against competition.*

Enron often introduces a product before the competition even senses a market exists. Cross-commodity trading, weather derivatives, energy outsourcing and 1999's two major initiatives—EnronOnline and Enron Broadband Services—demonstrate our resourcefulness. No wonder a *Fortune* survey recently named Enron the "Most Innovative Company in America" for an unprecedented fifth year in a row.

4. *Success in the New Economy requires the adroit use of information to restructure an organization and boost productivity.*

The connectivity of our networks allows us to gather massive amounts of market data to provide instant market snapshots and to identify emerging trends. This information is available to, and accessed by, every Enron marketer and originator in every part of the world, ensuring that we make informed moves and spot opportunities at the first possible moment.

The fluidity of knowledge and skills throughout Enron increasingly enables us to capture value in the New Economy.

### NETWORK ELEMENTS

Enron continues to be one of the most efficient developers and builders of physical assets. Assets form the foundation of network businesses that sell up and down the value chain. Layered on top of our physical assets are: (1) strategic contractual relationships, which ensure us access to other people's physical assets without owning them ourselves, and (2) our market-making ability, which allows us to draw on the most flexible, most efficient components to create higher-value products and services for our customers.

By structuring our operations as flexible networks, we can accelerate our growth with minimal capital expenditures. Physical assets play a strategic, but not central, role in the way we earn our money, and this reduced emphasis on merely earning a return on physical assets allows us to divest non-strategic assets and redeploy capital into higher-growth and stronger-return businesses. This led to several important transactions last year.

In August we completed a sale and exchange of our interest in Enron Oil & Gas Company (EOG). As part of this transaction, Enron retained certain international operations to create a global upstream function to serve our regional business units. The transaction generated approximately \$1 billion in cash

*Jeff Skilling, President and COO; Ken Lay, Chairman and CEO; and Joe Sutton, Vice Chairman*

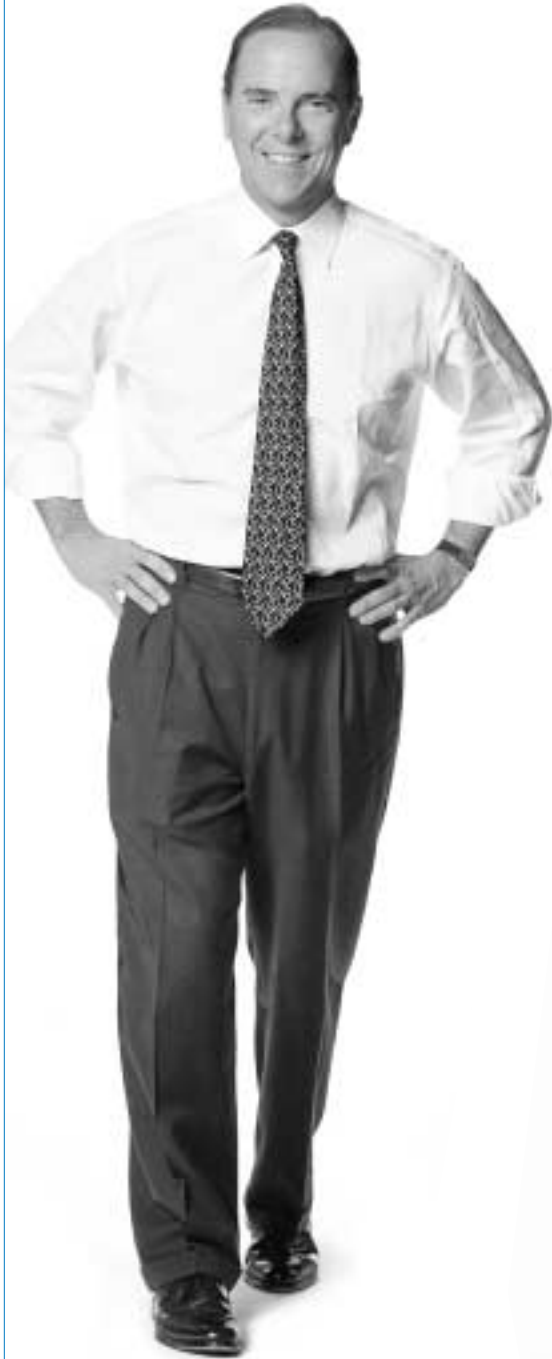

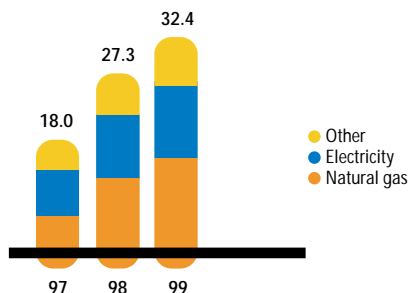

**WHOLESALE ENERGY OPERATIONS AND SERVICES – PHYSICAL VOLUMES**  
(trillion British thermal units equivalent per day)

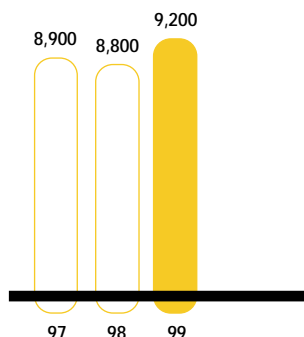

**TRANSPORTATION AND DISTRIBUTION – TOTAL VOLUMES TRANSPORTED**  
(billion British thermal units per day)

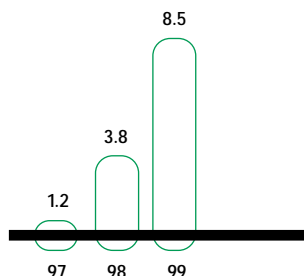

**ENRON ENERGY SERVICES – CONTRACTS ORIGINATED**  
(\$ in billions)

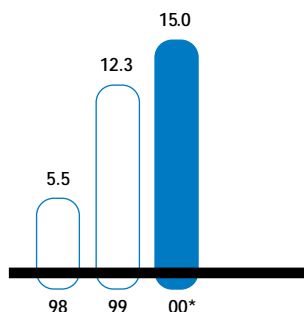

**ENRON BROADBAND SERVICES – ROUTE MILES OWNED OR ACCESSIBLE BY CONTRACT**  
(miles in thousands)  
\*estimated

proceeds that will be invested in other areas.

In November, we agreed to sell Portland General Electric (PGE) to Sierra Pacific Resources. PGE is an excellent organization, and our relationship has been mutually beneficial. At the time we acquired PGE, Enron needed additional insight into developing electricity markets, and we also required credibility to participate in the markets. We have gained the insight and credibility we sought, and we believe the sale of PGE represents the best value to Enron shareholders. After the sale, we will have approximately \$2 billion in cash proceeds to redeploy into businesses with faster growth and higher returns. The agreement is currently under regulatory review, with a final sale expected in late 2000.

#### EnronOnline

Enron's primary competitive advantage is to identify opportunities and gain an early lead that we never surrender. Clearly we have gained the first-mover advantage with our new eCommerce application, EnronOnline. Other services exist, but EnronOnline is the only global principal-based system that allows users to view real-time prices for a range of energy and related commodities and transact instantaneously. Its ease-of-use and price transparency have been enthusiastically received by our counterparties.

EnronOnline is increasing our overall volume of transactions and our market share. Ultimately, EnronOnline will become one of the world's largest eCommerce businesses. In 2000, we expect the notional value of goods bought and sold on EnronOnline to be at least \$40 billion, many times the value sold online by successful eMerchants such as Dell, Cisco or Intel. Furthermore, we will leverage EnronOnline to present more products and services, including many that do not yet exist. Clearly EnronOnline will be a significant catalyst for growth.

#### ENRON BROADBAND SERVICES

Enron's entry into the communications business is a logical extension of our skills and experience. The industry is strikingly similar to the natural gas industry of the mid-1980s. At that time, Enron remade an industry characterized by inflexible and rigid business relationships and contracts, which caused either crippling shortages or massive inefficiencies. Enron challenged conventional thinking and helped open the industry for effective competition. We have the capacity to develop a similar efficient market for bandwidth.

As EnronOnline demonstrates, the Internet is changing the way we do business. The public Internet, however, does not have sufficient bandwidth capacity to carry massive data and rich media content to the desktop. In 1999 we rolled out Enron Broadband Services to take the Internet to the next level. Demand for premium broadband delivery services is expected to soar by 150 percent annually from now through 2004. This market could easily surpass the combined markets for natural gas and electricity.

Enron Broadband Services is off to a tremendous start: we own and operate a superior intelligent fiber optic network that is focused on delivering bandwidth-intensive content, such as TV-quality video, over the Internet. Our goal is to be the premier

provider of high-bandwidth services and applications worldwide. The business model we follow is the one we used to create liquid markets for natural gas and electricity. We are establishing benchmark bandwidth contracts and making a market in bandwidth. We initiated the first bandwidth trade in December 1999. The market for bandwidth intermediation will grow from \$30 billion in 2000 to \$95 billion in 2004. With our head start, we expect to become the leader in this field.

#### 1999 ACCOMPLISHMENTS

In addition to executing our plans for Enron Broadband Services and EnronOnline, our employees helped us reach several significant milestones in 1999:

##### *Enron Energy Services*

In 1999 we proved that Enron's retail business works. We exceeded our goal by signing energy outsourcing contracts representing \$8.5 billion in total contract value, more than double the \$3.8 billion achieved in 1998. Enron Energy Services achieved positive earnings in the fourth quarter, and its profitability is expanding rapidly.

Our persistence in the retail energy market has given us an unassailable competitive advantage. While many companies waited on the sidelines to see how domestic electricity deregulation would progress, we built a business independent of deregulation. Now the retail energy outsourcing market is gaining momentum, and for the competition, catch-up will be a hard game to play.

##### *The widening of our lead in the North American wholesale energy markets*

We viewed 1999 as a milestone for Enron North America. Our position as No. 1 in multiple energy markets grew so strong that it no longer is challenged by any single competitor. Our volume of day-to-day merchant activities is extraordinary, and that volume will grow sharply as electricity deregulation accelerates and natural gas demand increases. In 1999 we executed our plan to quickly develop, site and build three peaking power plants, which were up and running in less than a year, to meet last summer's peak demand. These plants, designed to operate only when justified by electricity prices, are switched on directly from our power marketing floor in Houston.

##### *Enron Europe*

When fully opened, the size of Europe's wholesale electricity market will rival that of the United States, and Enron will be ready. We have had a presence in Europe since 1989; today we have 1,750 Enron employees throughout Europe to provide commodities marketing, risk management, gas services and wholesale electricity sales. We command a leading position in every energy market that has opened. With our competitors just opening up shop, we have a clear first-mover advantage.

##### *Developing Wholesale Networks*

Our wholesale networks in India and South America gained critical mass in 1999, paving the way for integrated, region-wide activities in both energy and broadband services. With the

completion of Phase I of the Dabhol Power Project in India and the successful financing of Phase II, we are well on our way to developing a natural gas network on the west coast of India. In South America, we have established natural gas pipelines and power plants and we operate electricity and natural gas distribution networks. Our vision of building an energy network throughout the Southern Cone is now a reality.

#### THE ENRON CULTURE

Creativity is a fragile commodity. Put a creative person in a bureaucratic atmosphere, and the creative output will die. We support employees with the most innovative culture possible, where people are measured not by how many mistakes they make but how often they try.

Our culture of innovation is difficult to duplicate. Individuals are empowered to do what they think is best, and most of our outstanding initiatives in 1999 came directly from our own ranks. Our philosophy is to not stand in the way of our employees, so we don't insist on hierarchical approval. We do, however, keep a keen eye on how prudent they are, and rigorously evaluate and control the risk involved in each of our activities. We insist on results, and the results have been quite good. Throughout this annual report, you will see how enthusiastic, motivated people have created their own networks of Enron-wide talent and resources to quickly advance ideas.

We are doing something that is recognized outside the company. This year, in addition to again naming us "America's Most Innovative Company," *Fortune* ranked Enron "No. 1 in Quality of Management" and "No. 2 in Employee Talent" of all American companies. The magazine also acknowledged us as one of the 25 best places to work in America. We recognize that our intellectual capital is our most important asset, and we cherish it. All employees are shareholders. Our values of communication, integrity, respect and excellence are equally applicable to our dealings with each other as with our customers and suppliers.

Increasingly, energy will serve as our entrée to customers who can benefit from Enron's intellectual capital and services. The fundamental skills and expertise we use to develop energy and communications solutions can be applied to many situations that inhibit our customers' profits and growth. It is that core of expertise, rather than tradition, that will define Enron in the future.



Kenneth L. Lay

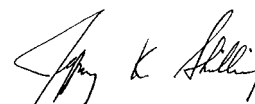

Jeffrey K. Skilling



Joseph W. Sutton

## WHOLESALE ENERGY BUSINESS

### Wholesale Developed Networks

#### ENRON NORTH AMERICA

Enron's footprint is everywhere in the North American wholesale energy business. We conduct hundreds of daily transactions, touching every part of the energy market. Generators, distributors, marketers and producers rely on us to make markets, transport, provide logistics and deliver the commodity. Wholesale competition thrives on services we provide, including risk management and capital.

For years, we have led the market. We view 2000, however, as a breakaway year when we will further widen the distance between Enron and the competition. No one can read the markets as we do, and no one responds as quickly. Together with Enron Europe we launched EnronOnline, our Internet-based commodity transaction service, in 1999. EnronOnline allows us to move more products to more customers than ever before. The system is revolutionizing the way energy commodities are traded, and we will

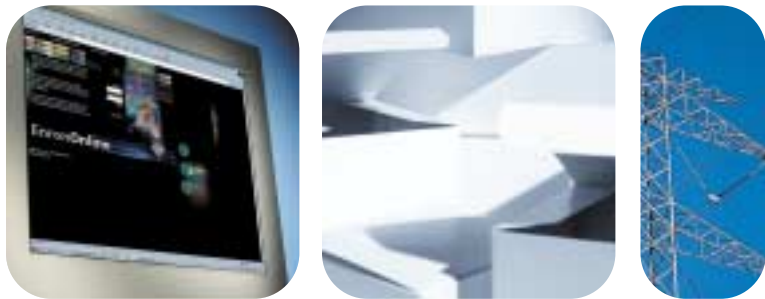

benefit from increased volume and market share. Since debuting last November, EnronOnline has significantly increased our daily volume of transactions. In its first two-and-a-half months of operation, the system completed more than 25,000 global transactions and did approximately \$9 billion of business.

#### Natural Gas

Although natural gas is our most mature business, we anticipate continued growth in volume and market share in 2000. The demand for gas itself is on the upswing, the result of a surge in new gas-fired electricity generation. Gas consumption by generators will increase to 8.8 trillion cubic feet (Tcf) in 2010 from 5 Tcf today. EnronOnline will be a magnet for much of this new business.

In 1999 we retained our position as the No. 1 gas merchant in the United States and Canada, with physical volume of approximately 13.3 billion cubic feet equivalent (Bcfe) per day.

#### Electricity

Enron marketed 381 million megawatt-hours of North American power in 1999. We clearly lead the market in wholesale electricity in the U.S., and that market is growing rapidly. As utilities divest their generation assets, the level of available merchant power increases. Today merchant power accounts for 25 percent of capacity. Within four years, we estimate that

number will exceed 50 percent. As the No. 1 electricity marketer in the United States, Enron is positioned to obtain a good portion of the increase in transactions.

In 1999 we built three single-cycle gas-fired power plants to produce 1,340 megawatts of peaking power. This power supports our market positions when power is scarce. The power provides greater flexibility to our merchant operations and increases reliability in previously underserved markets. In 2000 we will add three more plants with total capacity of approximately 1,600 megawatts. These six peaking units, located in Tennessee, Mississippi, Indiana and Illinois, serve the nation's most active and volatile electricity and natural gas markets.

#### Other Markets

Enron offers innovative products and services in different markets to meet the needs of high-volume energy producers and consumers.

We have developed a liquid market in coal, where we optimize commodity positions for producers and consumers. We have become the largest coal market-maker in the United States with more than 24 million tons delivered in 1999. We

provide risk management tools to stabilize earnings and make capital available to producers as well.

We have brought new liquidity and risk management skills to the pulp and paper industry. By making a commodity market in pulp and paper, we can supply financial risk management tools to shield paper companies from historic price volatility. Our clients include leading publishers, food packaging companies and paper and container board mills.

Other key markets include emission credits, crude petroleum products and weather derivatives. In addition, Enron has the financial strength to provide equity and debt investments in energy-related businesses, which can serve as our entrée to providing additional products.

#### ENRON EUROPE

Enron has seized the first-mover advantage in Europe. With no comparable competition in sight as the Continental European market opens to energy competition, Enron's pan-European network of assets, contracts and market-making ability is in place and ready for exponential growth.

A presence since 1989, Enron has 18 offices in 16 countries, staffed by 1,750 employees representing 42 nationalities. With all of Enron's intellectual capital and abilities, Enron Europe is thoroughly European and thoroughly Enron.

In just a few years, the competitive European wholesale power market will rival the size of the power sector in the United States. Enron expects to assume the leading position in Europe as it has done in North America.

We are the largest merchant of natural gas and power in the U.K., which liberalized its markets in 1992. Our gas volumes increased 21 percent in 1999 to reach 1,500 billion British thermal units equivalent (BBbtue) a day, while power volumes more than



tripled to 53 million megawatt-hours. In the Nordic region, the world's most deregulated electricity market, we are the largest power merchant. Our volume grew 48 percent from 1998 to reach 31 million megawatt-hours in 1999—10 times our marketing volumes in 1996.

Technology is used to fortify our market position. We offer PriceDesk, an online power pricing mechanism for utilities in the Nordic region, and Strommarkt, an online electricity pricing system in Germany. EnronOnline's unique transaction capability has further advanced Enron's technology lead. The system allows counterparties to buy and sell U.K. and Continental power and gas as well as other products. EnronOnline will revolutionize our business in Europe as well as in North America, helping us to gain significant market share. A truly global system, EnronOnline is available in different currencies, making it suitable for many of our diverse customers.

The European Union mandated liberalization of the power market in member states by February 2000. Competition is having a dramatic effect on Continental prices: for instance, in Germany wholesale prices have dropped 35 percent in less than a year. In that environment, we are a natural partner for utilities that need greater wholesale expertise to manage power supply and risk. As competition takes hold on the Continent, we are completing more transactions than any other company.

With Enron's broad array of products, we can find a way to sell energy services in almost any market. Our first transaction in Spain involved oil, our initial contract in Poland was for coal, France was receptive to a weather derivative transaction and natural gas has always been our strength in the U.K.

As Europe's appetite for wholesale transactions is whetted, Enron's business grows accordingly. Our numbers nearly tripled from 1998 to 1999. In 1999, we completed 24,240 transactions; marketing power volumes of 91 million megawatt-hours for the year and an average of 1,554 BBTue of gas per day.

Some European markets need additional assets to increase market liquidity, and we will build those assets where they make economic sense and add strategic value. Last year we completed construction of the 116-megawatt Nowa Sarzyna power plant in Poland and the 478-megawatt Marmara plant in Turkey. The 551-megawatt Sarlux combined-cycle oil gasification plant within the Saras oil refinery in Southern Sardinia, Italy, will be completed in 2000. We are developing the 240-megawatt Jertovec plant in Croatia as well as a 1,200-megawatt plant in Arcos, Spain.

Our goal is to build liquidity across Europe and serve as a strong catalyst for liberalization. As our European network expands, we will be able to lower costs, increase flexibility and expand our base of services to the marketplace, securing Enron's first-place position for the long-term.

#### *Wholesale Developing Networks*

Enron is developing wholesale energy networks throughout the world with a current focus on four regions: India, South America, Asia Pacific/Africa/China and Caribbean/Middle East.

*continued on page 10*

## *ENRON NORTH AMERICA*

# During the summer there are still brownouts in the U.S.

## *ENRON ASKS WHY?*



**STRATEGY:** DRAWING ON TALENT AND SKILL THROUGHOUT THE ORGANIZATION, ENRON SITED, BUILT and brought three peaking units online within 12 months to successfully capture the high margins of Summer 1999.

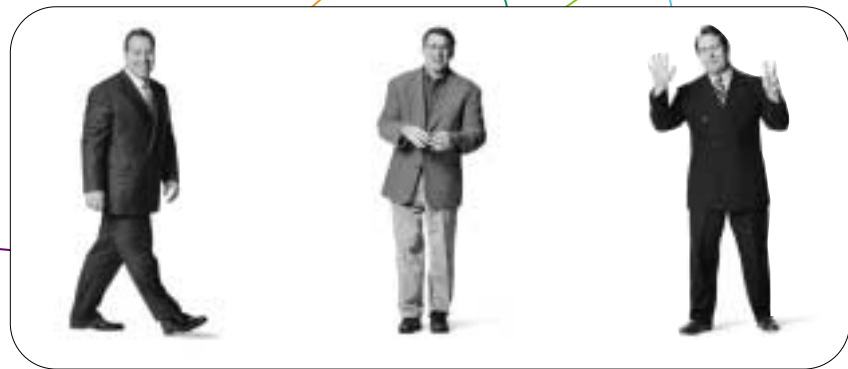
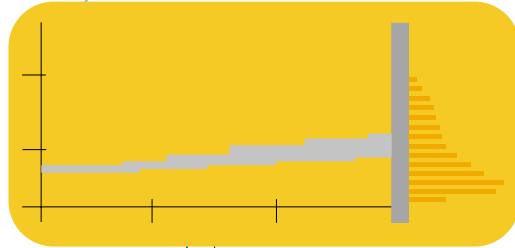

**RESEARCH TEAM**

Enron's in-house mathematicians and physicists analyze power-supply-and-demand patterns throughout the United States. The team uncovers two regions—the Southeast Reliability Council and the Midwest Reliability Council—that are likely to face shortages within two or three years. A plan of action emerges: site three plants in the Southeast in 1999 and additional plants in the Midwest in 2000.

**FINANCIAL EXPERTS**

How profitable will the peaking units be? Enron's financial experts work with the research team to run thousands of financial simulations to project the best-, worst- and middle-course scenarios. The result is a comprehensive risk-adjusted return on capital analysis, which allows Enron to know with certainty whether building peaking units is a judicious use of company capital.

**GENERATION SERVICES GROUP**

The Generation Services Group—Mike Miller, Greg Whalley and Dave Delainey—looks closely at the U.S. generation market. At first glance, it looks bleak. With deregulation, electricity could become a low-margin commodity. But the group won't say no until it exhausts all possibilities. It uncovers a fantastic opportunity—developing peaking units that would be turned on only when justified by electricity prices. It draws on Enron resources to respond in record time to develop three plants in two states simultaneously.

**POWER-ON-DEMAND**

**RESULT: THREE PEAKING UNITS ARE AVAILABLE TO OFFER A TOTAL OF 1,340 MEGAWATTS DURING PEAK power demand:**

*Brownsville Power, Brownsville, Tennessee, 475 megawatts*

*Caledonia Power, Caledonia, Mississippi, 475 megawatts*

*New Albany Power, New Albany, Mississippi, 390 megawatts*

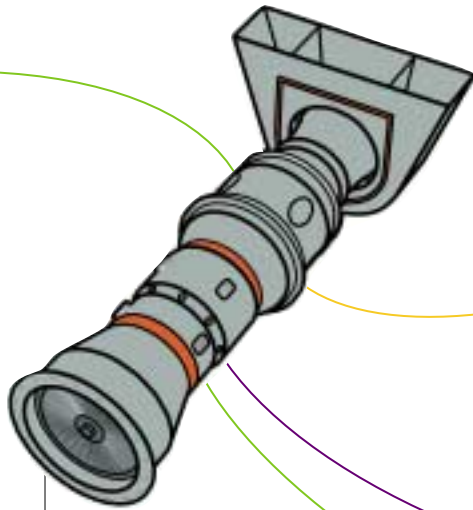

ENRON ENGINEERING & CONSTRUCTION COMPANY	THE POWER TEAM	GOVERNMENT AFFAIRS AND PUBLIC RELATIONS
<p>Enron Engineering &amp; Construction Company (EE&amp;CC) drives Enron's global development activities. Engineers design the perfect plant to deliver peaking power—a low-cost, single-cycle natural gas-fired plant that can be fired up within 30 minutes to an hour. Faced with a shortage of turbines in the U.S., EE&amp;CC uses its world-wide contacts to scout out used turbines in South Korea. EE&amp;CC disassembles and transports them to Pensacola, Florida, where it hires subcontractors to refurbish the equipment.</p>	<p>Kevin Presto and Roger Herndon use their knowledge and experience in electricity trading and generation to review historical data and project forward demand for electricity. They know during peak times electricity prices will soar from \$17 or \$22 per megawatt hour to \$35, \$60 or even thousands of dollars per megawatt hour. At peak prices, the profit margins are enormous. Once the plants are finished, the trading group makes the decision to dispatch power. It turns on the plants right from the Houston trading floor.</p>	<p>With widespread knowledge of state and local regulations, the regulatory affairs group suggests locations and strategies to accelerate the process of securing permits for the new sites. The group helps shorten the review time for air permits by qualifying plants as limited-run operations. Public relations professionals work with local civic groups, government officials and media to introduce Enron and foster understanding of the project.</p>

## DABHOL: THE FOUNDATION OF ENRON'S INDIA NETWORK

*The Dabhol Power Project, located on the coast approximately 100 miles south of Mumbai in the state of Maharashtra, is Enron's entry into India. With the financial close of the second phase of the Dabhol Power Project in May 1999, Enron has gained a pre-eminent position in the west coast natural gas market of India and is poised to launch India's first broadband network. Here is how Enron's India network was built:*

DABHOL PHASE I	DABHOL PHASE II
Enron responds to India's private power initiative in 1992 to develop the country's first internationally owned independent power project. Enron becomes India's largest foreign direct investor and an early participant in the country's dynamic economic development. The first phase of the Dabhol Project, with 826 megawatts of generation capacity, begins operating in May 1999.	Enron closes the US \$1.87 billion financing of the second phase of the Dabhol project in May 1999. The financing includes a liquefied natural gas (LNG) terminal and regasification plant, allowing India to import natural gas for the first time. Enron contracts to purchase 2.1 million tons of LNG from Oman and Abu Dhabi to supply Dabhol when the second phase of 1,624 megawatts is completed in fourth quarter 2001. Dabhol will generate 2,450 megawatts of power, making it the world's largest independent natural gas-fired power plant.
LNG TRANSPORT	ENRON GLOBAL EXPLORATION & PRODUCTION
To ensure smooth delivery of LNG from the Middle East, Enron partners with Mitsui OSK Lines and the Shipping Corporation of India to finance and begin construction of an LNG shipping vessel dedicated to transporting fuel to Dabhol. This marks the first involvement of an Indian company in LNG shipping, as well as the first project financing of an LNG vessel.	To boost India's indigenous supply of natural gas, Enron is developing natural gas and oil reserves in three west coast offshore fields. Current production is approximately 290 million cubic feet per day of gas and 25.5 thousand barrels per day of oil. Domestic gas can be blended with imported gas to increase the volume of gas sold and improve pricing.
METROPOLIS NATURAL GAS PROJECT (METGAS)	MERCHANT OPPORTUNITIES
Dabhol's LNG facilities can receive and process 5 million tons of LNG annually, about 3 million tons more than the power plant will consume. Enron forms Metgas to transport and market additional gas capacity to third-party buyers, such as other power producers and various manufacturers. Metgas is developing a pipeline north of Dabhol and southward to Karnataka and is well positioned to become the leading gas distribution company in the state of Maharashtra.	Enron is positioned to extend its market-making capabilities to India as that country's wholesale market for energy develops. It will introduce gas supply agreements, energy price risk management and other energy services as the India market liberalizes further.
GAS AUTHORITY OF INDIA LTD.	ENRON COMMUNICATIONS INDIA
Enron participates in the Indian Government's disinvestment program and purchases 5.1 percent of the Gas Authority of India Ltd. (GAIL) through a Global Depository Receipt offering. GAIL operates the country's only long-distance gas pipeline, which runs from Hazira on the west coast to the country's capital, New Delhi.	Enron's foray in communications in India is centered on providing integrated and complete end-to-end broadband capacity and applications. This includes developing international fiber and satellite capacity and establishing an intelligent terrestrial fiber network that will link up with data centers in large metropolitan centers. On this enabling platform, Enron plans to deliver broadband capacity and cutting-edge broadband applications developed by Enron and leading software companies. Furthermore, Enron has great confidence in India's potential as an information technology superpower, and aims to play a role in facilitating its growth.

In 1999 we started up the first phase of the Dabhol Power Project, an 826-megawatt power plant, and completed the financing of the second phase, which consists of an additional 1,624 megawatts and India's first liquefied natural gas (LNG) facility. Phase II lays the cornerstone for a vast India energy network that will serve as a springboard for multiple Enron businesses, including broadband services, in the region.

Since coming to India in 1992, Enron has become synonymous with commitment, responsibility, excellence and action. This image has allowed us to rapidly develop network assets, enter markets and ultimately will enable us to participate in every stage of the natural gas and electricity energy value chain as well as in the communications business.

India is a technologically advanced society, populated by sophisticated computer users, and is a large consumer of entertainment such as movies and television. Enron Broadband Services is in India to develop a fiber optic network, high-bandwidth applications and data centers. Our familiarity with the country and its regulations, our dynamic India network and our reputation will hasten the development of this market.

In Asia we are concentrating on two mature economies that are restructuring their energy markets: Japan, the fourth-largest energy market in the world, and South Korea, the 13th. The Japanese power market is scheduled to open in March and is a natural market for specialty products such as coal and crude oil intermediation and financial risk management instruments. Enron will assemble a network of assets, alliances and market activities to offer as broad a range of products as possible.

We have staked out an excellent position in South Korea, which soon will open its electricity and gas markets. In 1999 we formed SK-Enron, a joint venture with SK Corporation, one of South Korea's largest conglomerates, to manage SK's natural gas and liquefied petroleum businesses. Additionally, we acquired interests in three gas utilities and a cogeneration power plant, positioning ourselves for significant growth.

Our Australian office, launched in late 1998, is capitalizing on that country's open power market. EnronOnline will begin to transact Australian power in March. The market for gas is deregulating concurrently, and our merchant efforts will grow with the market.

In South America, Enron has built an integrated asset base of natural gas pipelines, local gas distributors, power plants and electricity distribution in the Southern Cone countries of Brazil, Argentina and Bolivia. Now that the network is complete, we are initiating wholesale merchant transactions from offices in Buenos Aires and Rio de Janeiro.

In 1999, 30 million cubic meters, or 1.06 million cubic feet of gas, per day began to flow through the Bolivia-to-Brazil pipeline, developed in partnership with others. The first 480-megawatt phase of our Cuiabá generating station in Brazil began to produce 150 megawatts of electricity on an emergency basis; the second phase is set to start up by mid-2000.

In 1999 we were able to increase our ownership of Elektro Eletricidade e Serviços from 47 percent to nearly 100 percent. Elektro is Brazil's sixth-largest electricity distributor, serving São Paulo State. We are leveraging Elektro's excellent reputation and customer reach to begin originating individual wholesale transactions in its service territory.

In the Caribbean in 2000, we will begin operating EcoEléctrica, a combination 500-megawatt power plant and LNG receiving facility in Puerto Rico. EcoEléctrica creates the commonwealth's first natural gas supply and will help develop Enron's global LNG business.

Enron is pursuing development opportunities in Africa. As with all asset development, we will proceed with infrastructure projects that will serve strategic interests over time.

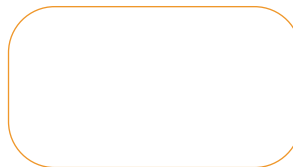

## **ENRON WIND CORP.**

Enron provides vertically integrated wind power solutions through Enron Wind Corp., one of the world's largest commercial wind turbine manufacturers. We have sold and/or developed more than 4,300 wind turbines, comprising more than 1,400 megawatts of capacity globally.

With the robust European wind market, an extension of the renewable energy production tax credit in the United States and the world's growing environmental concern, wind power is forecast to continue expanding at a rapid rate. Through our manufacturing facilities in California and Germany, a new plant currently under construction in Spain and our advanced wind turbine technologies for on- and off-shore use, Enron is meeting increased demand for wind power.

*EnronOnline*

# No one trades energy over the Internet.

## **ENRON ASKS WHY?**



**STRATEGY:** eCOMMERCE OVER THE INTERNET IS THE NEW STANDARD FOR BUSINESS-TO-BUSINESS

transactions; Enron creates EnronOnline, the first global transaction system to bring worldwide energy markets into the Internet age. Customers have complete 24-hour-a-day computer access to Enron's prices in all Enron global wholesale markets. They can execute transactions with Enron instantly with a click of their mouse. To establish first-mover advantage, Enron's traders set an aggressive timetable—just seven months—to launch EnronOnline. A global team of more than 350 traders, technology experts, lawyers and other Enron experts is assembled to design a secure, legally sound and easy-to-use service.

**PROJECT HEAD**

In late April 1999 Enron's head traders sense the time is right to advance to the next level of wholesale energy transactions. Louise Kitchen, then head of European Gas Trading, takes up the challenge to execute the launch of a global Internet-based commodity transaction system. Louise draws on Enron's global network of intellectual capital to mobilize a team. Its goal is to break down geographical boundaries and connect Enron's worldwide trading capability and customer base via the Internet, while ensuring compliance with international regulatory and cultural restrictions. For the next seven months Louise's core team drives the development, design and implementation of a web site that simplifies and expedites transactions with Enron.

**GLOBAL TRADING OPERATION**

Without Enron's strong presence and volume in international commodity markets, it would not have the liquidity to make markets in hundreds of products, or the experience and pricing knowledge to operate throughout the world. Each trading group helps design the suite of systems that maintains prices on the web site, while individual traders specify special product requirements. EnronOnline becomes a system for traders designed by traders. Training on EnronOnline begins in August 1999, with traders participating in global simulations to ensure a flawless launch. The first transaction is completed at 9:52 a.m. on November 29 by the traders on the U.S. Natural Gas Central Desk.

**EnronOnline OPERATIONS**

To ensure a first-class customer experience, a dedicated operations team is created from Enron's broad business support network. EnronOnline Operations is a global group with expertise in marketing, contract management, customer data processing and more. The immense volume of data—from the 120 different contracts to the changing of customer addresses—is maintained on a continual basis. Providing premier service to internal and external customers is the driving force behind this group, which offers 24-hour HelpDesk support in more than 140 languages to assist in the registration and transaction processes.



**EnronOnline**

**RESULT:** EnronOnline DEBUTS ON NOVEMBER 29, 1999, COMPLETING TRANSACTIONS WITH A NOTIONAL value of more than \$9 billion during its first two-and-a-half months. All of the hundreds of wholesale products that Enron currently offers, ranging from Canadian natural gas and German power to weather derivatives and pulp and paper, can be transacted through EnronOnline. Customers navigate across the web site to manage their energy portfolios free of charge. Already, Enron envisions EnronOnline as a portal with much more potential. As Enron enters new markets with additional products, the scalability of EnronOnline will allow new customers to "click and transact" almost anything Enron can offer.

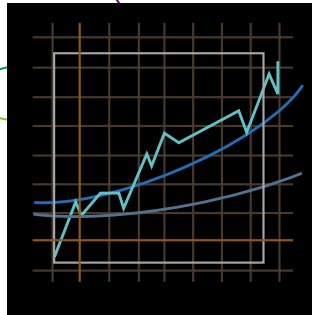

#### CREDIT/FOREIGN EXCHANGE/RISK ASSESSMENT AND CONTROL (RAC)

Online transactions happen so fast and volumes can be so great that credit decisions are required on a continual basis. Therefore, automated credit and risk assessment control functions are built into the EnronOnline system. Each customer transacting on EnronOnline requires a continuously updated customer profile with credit and term limits for every product type. All transactions are automatically and instantly screened for credit approval before acceptance. Because this is a global system, Enron's Foreign Exchange Desk quotes currency rates that are then incorporated into the commodity pricing on a real-time basis to ensure that prices reflect the underlying exchange rates. Any completed currency-related transactions flow automatically into the foreign exchange systems.

#### INFORMATION TECHNOLOGY (IT)

Enron, recognized as an innovative user of technology by *Information Week* and a leading player in the New Economy by *Wired* magazine, faces an unusual challenge with EnronOnline: it must ensure that prices posted by traders are up-to-the-minute and transactions can occur securely across the Internet. Chief Technology Officer Philippe Bibi mobilizes his global team, led by Jay Webb. It is no small feat to provide a continual stream of price updates for hundreds of products, each requiring individual design and support. IT not only ensures the smooth integration of EnronOnline into the existing IT network infrastructure but also seamlessly connects it to the back office systems for contract settlement, risk management and commodity scheduling. Finally, IT manages the web site day to day as markets open and close across the globe.

#### LEGAL AND TAX

What turns a mouse click into a legally binding contract? Enron's legal team works with the project leaders to create a framework for online transactions that meets global requirements. Legal teams in each country engineer specialized electronic commodity trading agreements that can be accepted by the customer online. The team must deal with hundreds of legal issues and regulatory standards for each country. The tax group ensures that EnronOnline accommodates the statutes of all international as well as domestic jurisdictions, and both teams monitor ever-changing regulations for eCommerce.

## ENRON BROADBAND SERVICES

In a world where the Internet can't keep up with the demand to deliver high-bandwidth, rich media content, Enron Broadband Services is moving boldly to establish a global platform for premium broadband delivery services.

Enron Broadband Services is leveraging a pure fiber optic domestic network with exceptional applications to make high-bandwidth content delivery—such as video and intensive data transfer—more efficient, cost-effective and convenient than ever before possible.

High-bandwidth content delivery is the next level of Internet performance and an essential platform for eCommerce. Today, graphic-intensive rich media ads account for 1 percent of Internet ads. By 2002, 60 percent of all Internet banner ads will be rich media, according to Jupiter Communications, which will heighten the demand for faster data delivery. The market for premium broadband delivery services is expected to soar by 150 percent annually from 2000 to 2004.

We are a unique, single source for every broadband service: a mixture of hardware, software, market-making, finance and applications. Virtually anyone involved in communications is a potential customer—content providers, application developers, network carriers, Internet service providers and corporate end-users. We are approaching this sizable market with the same scale and scope we successfully bring to every single Enron business.

Three components lie at the heart of Enron Broadband Services:

- The Enron Intelligent Network. A state-of-the-art high-capacity fiber optic network, based on a distributed server architecture, the Enron Intelligent Network's global fiber and satellite distribution and embedded software intelligence sets it apart from other network providers. The Enron Intelligent Network bypasses traditional fragmented and bottlenecked public Internet routes to deliver faster, higher-quality data. Enron's Broadband Operating System (BOS) provides the intelligence to the Enron Intelligent Network and connects to all physical and software network elements.
- Bandwidth intermediation for real-time bandwidth-on-demand. Unless it travels a dedicated network, data must pass through a relay of several separate network operators to its final destination. It can take months to negotiate capacity purchases with so many parties involved. Enron can serve as a bandwidth market-maker, buying pooling-point-to-pooling-point bandwidth inventory that it will resell on an as-needed basis at real-time market rates. Buyers will dramatically cut costs by paying for only the bandwidth they use, at prices that reflect the current market.
- Enron's content services for managing and delivering high-bandwidth applications. The Enron Intelligent Network and Enron's BOS enable a new genre of application services, called

ePowered™ Services, which transport rich media and live, streaming video up to 50 times faster than the public Internet. A carrier using Enron's technology could transmit a broadcast-quality five-gigabyte video file, such as a full-length movie, in 16 seconds—something that takes seven hours on a T-1 line. Customers for ePowered Services include media and entertainment, financial services, general enterprise and technology companies.

### THE ENRON INTELLIGENT NETWORK

Enron Broadband Services has gained instant credibility, striking alliances with the biggest and brightest names in the industry, including Lucent Technologies, Cisco Systems and Inktomi. In a move to accelerate development of the business, Sun Microsystems has agreed to help build out the Enron Intelligent Network. Enron and Sun will jointly market Enron Intelligent Network services to enterprises, software developers and service providers.

Our history and our track record also adds credibility. We have proven that we can make markets that others thought



impossible, such as in electricity, natural gas and pulp and paper. We have, or have acquired, the requisite skills to develop new types of broadband services, to market bandwidth capacity and to launch ePowered applications. We have the intellectual capital to build this business.

A network business model gives Enron Broadband Services scalability and flexibility. In the United States, we own or have contractual access to a 14,300-mile network, which is scheduled to expand to 18,000 miles in 2001. The network connects to every major U.S. city and soon will be linked to Tokyo and six major European cities.

### BANDWIDTH INTERMEDIATION

From this asset base, we are building a robust merchant operation. Bandwidth intermediation opportunities are enormous. Analysts predict that the market will exceed the combined markets for electricity and natural gas. As the first-mover, Enron is shaping this market as it emerges. We are creating the "pooling points," where data is transferred from the public Internet to broadband fiber networks. Pooling points are to bandwidth what Henry Hub is to gas and COB is to electricity—a city gate uptake and download, a necessary reference point on which to base trading.



We completed the first bandwidth trade in December, a monthly incremental contract for DS-3 bandwidth between New York City and Los Angeles on a Global Crossing network. (DS-3 can move 45 megabits per second, enough for streaming video.) We are establishing and pricing that contract as a benchmark. In the second quarter, we will launch a second benchmark, a monthly contract between New York and London. In 2000 we know that bandwidth trading will gain acceptance in the market, and by 2001 we believe the market will reach critical mass.

The same skills apply to the bandwidth market as to merchant energy services, and we have transferred some of our most dynamic trading professionals from our North American and European energy networks to Enron Broadband Services. Our plans call for providing risk management products, structured finance, investment and bandwidth portfolio management to the broadband market. We envision working with data-dependent customers to outsource their broadband assets and needs. As quickly as this market develops, we will introduce more innovative products and services.

#### CONTENT SERVICES

Enron Broadband Services is strategically positioned where traditional television broadcast and the web converge. Companies want to stream entertainment and information on the Internet, and we can make it happen. Deploying ePowered applications over the Enron Intelligent Network, we can convey rich media content at high quality with no delay. Using our services, media companies can deliver broadcast-quality programming on the web, and financial services firms can present more compelling content. The Country Music Association used the Enron Intelligent Network to webcast additional footage from its annual Country Music Awards in 1999. We also facilitated a simulcast webcast of Warner Brothers' *The Drew Carey Show* last fall. Latinsoccer.net, a premier Latin American Internet portal for soccer fans, has selected Enron to carry live soccer matches to viewers' desktops.

The entertainment market is only the beginning. eCommerce looms large as a driver of demand. Not only can Enron enable retailers to enhance their shopping sites with video, we also can help them manage data with storing and archiving assistance. In an information-based society, broadband services is becoming an essential, high-growth business.

## ENRON BROADBAND SERVICES

The Internet is too slow and unreliable to support high-bandwidth content and the rich media needs of eCommerce.

## ENRON ASKS *WHY?*



**STRATEGY:** ENRON ASSEMBLES A FIBER OPTIC NETWORK TO DELIVER HIGH-QUALITY RICH MEDIA

content to end-users. It connects the network to the public Internet via the Enron Intelligent Network and develops the Broadband Operating System to control the network's physical and software elements. Enron sees that bandwidth capacity can be traded as a commodity and conducts the first bandwidth trade in 1999.

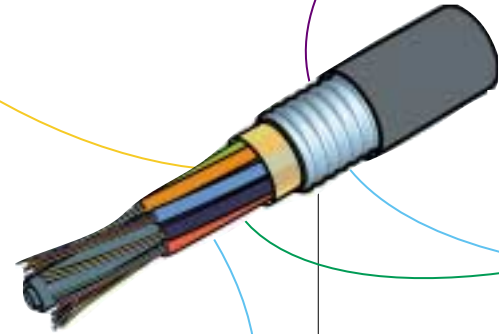

**THE DREAM TEAM**

In late 1998, Enron forms Enron Broadband Services to develop a fiber optic business. Joe Hirko, former Portland General Electric CFO, and Ken Rice, former chairman of Enron North America, are called in to capture every possible opportunity in the high-bandwidth market. They attract the industry's leading technological minds to assemble a high-bandwidth network of superior hardware, intelligent software and innovative products and applications. They draw on talent throughout Enron to explore all possible bandwidth business opportunities.

**ENRON INTELLIGENT NETWORK (EIN)**

Enron acquires Modulus, the creator of InterAgent software, which adds embedded ePowered™ intelligence to the network. The EIN's unique hardware architecture works off a chain of servers and distributed servers to avoid the delay of sending data through multiple routers. The EIN can be accessed on demand and users pay according to use, negating the need for their own investment in high-bandwidth connectivity.

**PHYSICAL NETWORKS**

Enron augments its initial 1,700 miles of fiber optic cable by building, swapping and leasing additional capacity in the U.S. By early 2000, Enron has access to 14,300 route miles. To upload and download content from the Internet, the company establishes points of presence, pooling points and data centers in 30 strategic markets. Leasing fiber keeps capital investment to a minimum. At the same time, the unit benefits from strong sales of dark fiber and data transmission.

# ENRON BROADBAND SERVICES

**RESULT:** THE ENRON INTELLIGENT NETWORK ALLOWS CONTENT AND INTERNET PROVIDERS TO TRANSPORT rich media and streaming video right to the desktop with no delay or quality reductions. Bandwidth trading permits customers to buy bandwidth capacity as needed and avoid the cost of full-time, underused capacity. Enron is accepted as an Internet innovator and strikes an alliance with Sun Microsystems to advance Enron's Broadband Operating System as the industry standard protocol.

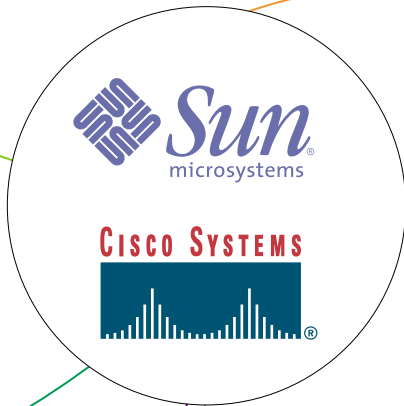

STRATEGIC PARTNERS	ePOWERED APPLICATIONS	BANDWIDTH TRADING AND CONTENT SERVICES
<p>Best-in-breed technology is obtained through strategic partnerships with the industry's leaders: Cisco Systems® routers, Sun® Microsystems servers and Ciena® dense wave division multiplexors—equipment that is unsurpassed in moving data and content. As partners, these Internet luminaries give Enron instant credibility with customers and assist in forming new relationships.</p>	<p>The EIN moves data up to 50 times faster than current Internet speed and reduces average data latency from approximately 29 seconds to 3 seconds. Media streams on the EIN like nowhere else, and Enron capitalizes on the EIN's speed and responsiveness to launch unique and lucrative ePowered applications, including:</p> <ul style="list-style-type: none"> <li>• ePowered Media Cast™ delivers broadcast-quality video to the desktop. That allows the Country Music Association to simulcast additional video from its annual Country Music Awards broadcast using ePowered Media Cast.</li> <li>• ePowered Media Transport speeds video content wherever it needs to go, bypassing satellite and land-based networks.</li> </ul>	<p>Veteran Enron North America market-maker Tom Gros recognizes that bandwidth capacity should be bought and sold via standardized contracts, similar to the way natural gas and electricity are marketed. He brings in Jean Mrha and other experienced Enron traders and in December 1999 initiates the first-ever forward trade of bandwidth between New York and Los Angeles. By serving as a market intermediary, Enron reduces the cost and increases the flexibility of purchasing bandwidth capacity and helps bandwidth producers and consumers manage price and supply risks. David Cox sells services directly to content providers, such as entertainment and media companies.</p>

## RETAIL ENERGY SERVICES

Enron's retail business surpassed our goals in 1999 when we signed contracts representing \$8.5 billion of customers' future energy expenditures. The unit turned profitable in the fourth quarter, marking the end of our start-up phase. With systems and people in place, we are set for exponential growth and sharply increased profitability. In 2000 we expect to again double our total contract volume to more than \$16 billion.

Enron has taken the lead in a rapidly expanding \$243 billion U.S. retail energy market. With our experience, international presence and breadth of service, Enron alone has the scale and capability necessary to provide major customers with the quality of service they expect. In addition to Houston headquarters staff, Enron maintains eight U.S. district offices with 250 professionals and manages services at 16,500 sites with 4,500 contracted employees. This structure helps make Enron the only energy outsourcing provider with nationwide reach.

In 1999 the retail group signed contracts with scores of customers, including 10-year contracts with Owens Corning, Polaroid, Simon Property Group and the U.S. Department of Defense. Furthermore, existing contracts provide significant upsell opportunity, as the majority of Enron's large retail customers recognize opportunities and request services beyond the scope of their initial contracts.

The proposition at the heart of Enron's retail energy business is a simple one: energy management is not a core business strength for most companies. Few companies have the expertise to approach energy strategically, and often energy infrastructure and equipment are not adequately maintained and updated. In addition, companies that use large amounts of energy can realize substantial benefit when they are able to optimize electricity and natural gas purchases, benefiting from lower prices and gaining protection from unpredictable price spikes.

When energy management is outsourced to Enron, we look at the entire energy supply chain, identifying which equipment must be updated or replaced, financing the cost of more efficient equipment and using our extensive experience in energy markets to manage the cost of the commodity. As a result, companies can reduce energy expenditures and gain significant competitive advantage in the marketplace.

Enron draws on existing businesses, resources and experience to structure comprehensive customer solutions and capture value throughout the retail transaction:

- We manage the commodity supply or supply it ourselves and manage the commodity price risk.

- We can provide labor outsourcing for energy and facilities management.
- We offer both our own capital and our financing capabilities to structure and syndicate financial transactions.

Enron's success in retail energy is not dependent on retail energy deregulation. At the close of 1999 only 23 states were in the process of opening electricity and natural gas markets to competition. Enron focuses on non-regulatory opportunities, such as improving operations and energy infrastructure, negotiating utility rates, gathering and analyzing energy usage information and managing complete facilities such as manufacturing plants and retail outlets. And energy consumption is not our sole focus: Enron's analysis of a retail customer's energy use includes examination of less obvious factors in the customer's energy cost, such as operating processes and the use of labor resources.

### CUSTOMER FOCUS

Enron's retail initiative relies heavily on the ability of our sales teams to bring in customers, both large and small, who never realized the potential benefit of energy outsourcing. In 1999 *Sales & Marketing Management* magazine named Enron the No. 1 sales team in the United States, citing our ability to develop customized solutions and target *Fortune* 500 companies. Enron has also developed the capability to deliver energy services that take the best from Enron's experience in the wholesale

energy business and combine it with responsive customer service. The result is a remarkable ability to create value through outsourcing contracts.

Enron is augmenting the retail market with new products and services. We compiled the first indexes for retail electricity—the Enron Energy Indexes—published weekly in *Megawatt Daily*. These indexes, used as benchmarks for the pricing of retail power, foster end-user energy price transparency and are fast becoming the de facto standard for retail pricing.

We are committed to deliver continuously superior service to customers over the long term. To ensure that we are serving our customers well, we have established an interactive web-based system to measure customer satisfaction. The system is founded on key performance measures set by the customer and Enron. This information system helps us determine if other sales opportunities exist with the customer, and whether both the customer and Enron are deriving value from the relationship.

The engineering and technical expertise required by Enron's retail energy business is applicable across all customer segments, including food processors, retailers, real estate investment trusts, manufacturers and sports facilities.

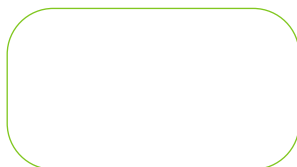

## INTERNATIONAL POTENTIAL

Enron extended its retail network to Europe in late 1999. By building on Enron's European wholesale network, our retail operation is expected to achieve first-year positive earnings. Our retail competitiveness on the Continent is enhanced by our reputation in pan-European wholesale operations and by our knowledge of working in individual countries. As in the United States, it is not necessary to wait for full energy liberalization before moving into the European retail energy market.

Enron alone has the critical mass to roll out a pan-European network. And for our North American customers with European facilities, we are the vendor of choice for their operations abroad.

Enron's wholesale operations also are laying the groundwork for the retail energy business in other regions. Mature energy markets, such as Japan and South Korea, where Enron has opened wholesale energy operations, have great potential for retail business as these countries continue the trend toward liberalization.

## *ENRON ENERGY SERVICES*

Most companies operate undercapitalized and inefficient energy infrastructure and bear unnecessary cost and waste.

*ENRON ASKS WHY?*



**PROBLEM:** ENERGY IS A LARGE EXPENSE AT OWENS CORNING, ONE OF THE WORLD'S LARGEST MELTERS OF glass to make fibers for insulating and reinforcement products. Owens Corning already was capitalizing on various energy management programs, including interruptible power, but was looking to further reduce its energy expenses while decreasing or eliminating the risk of losing power during peak usage.



#### CUSTOMER

Owens Corning seeks an energy partner that can reliably serve the company on a national and international basis. Enron is the only company with worldwide reach and the ability to provide a packaged solution that includes commodity purchasing and energy equipment financing, as well as engineering and risk management. As talks progress, Owens Corning is impressed by Enron's ability to quickly present and execute new energy solutions. Enron's focus on environmentally beneficial energy solutions also is important to ecology-minded Owens Corning.

#### LEAD TEAM

Harold Buchanan, managing director, and Michael Mann, vice president, lead a team of experts during the analysis, structuring and negotiations to find out all they can about Owens Corning's operations and needs. Extensive discussion and examination of data are necessary to design the best customized solution.

#### FINANCING

Financial engineering specialists Larry Derrett, vice president, and Clint Freeland, director, create and discard dozens of financial structures until they hit upon the right one: the formation of a jointly owned limited liability company (LLC) empowered to execute the agreement. The LLC serves as a platform for joint decision-making, shared savings and energy equipment leasing. Energy savings will offset the customer's leasing costs. Enron arranged the financing for the transaction.



# OWENS CORNING PARTNERS

**RESULT:** WITH DOZENS OF ENRON EXPERTS TACKLING THE PROBLEM, OWENS CORNING CAN EXPECT meaningful energy savings as well as improved efficiency and better power quality. Through a 10-year partnership valued at \$1.3 billion, covering 22 U.S. Owens Corning facilities, Enron will finance and refurbish specific energy infrastructure projects and allow Owens Corning to buy energy at advantageous rates.

MEGAWATT DAILY ENRON RETAIL ELECTRICITY INDEXES			
INDEX REGION	Primary Index	Secondary Index	Wholesale Index
NPCC-NEPOOL	0.0911	0.1062	0.0283
NPCC-NPP	0.0808	0.0973	na
MAAC1	0.0544	0.0761	0.0237
SERC	0.0437	0.0535	0.0227
FRCC	0.0517	0.0569	0.0239



COMMODITY PRICE RISK MANAGEMENT
<p>Enron will use its experience as the world's largest marketer of electricity to effectively predict the market cost of electricity using its retail electricity indexes published in <i>Megawatt Daily</i>. The risk management team designs a unique structure based on the indexes to protect Owens Corning from substantial price spikes that historically occur. Owens Corning is immune to day-to-day electricity price fluctuations. Enron manages the risk systematically through its large portfolio of commodity contracts.</p>
DEAL STRUCTURING & ACCOUNT MANAGEMENT
<p>Enron assigns point persons to oversee deal development and account management. Michael Moore, vice president of deal structuring, creates the scope, transaction components and pricing solutions covering every aspect of the deal—commodity transactions, construction management, project management, legal, tax, regulatory, accounting and more. By looking at the total picture rather than each individual piece, Owens Corning and Enron significantly increase the potential savings. After the LLC is formed, Barbara Kortes is named global account manager to provide continuing service and coordinate Enron resources for the account. She looks out for the customer's interests and works with Owens Corning to expand the relationship to overseas facilities. Already, Enron has engineered a backup generation system for a plant in Brazil.</p>
ENGINEERING
<p>A team of electrical and mechanical engineers led by Cynthia Wishert evaluates Owens Corning's energy infrastructure and proposes updating air-compression systems and steam boilers. Owens Corning is not driven to refurbish equipment because the investment does not meet its internal rate of return criteria. However, Enron's buying power and ability to squeeze efficiencies throughout the energy supply chain enables Enron to install state-of-the-art assets and recover their cost.</p>

**WITH ENRON**

## TRANSPORTATION AND DISTRIBUTION

### THE GAS PIPELINE GROUP

Enron's Gas Pipeline Group owns interests in four interstate pipelines, operates 32,000 miles of pipelines in 21 states and transports 15 percent of U.S. natural gas. Returns are strong and stable from the group, which produces consistent earnings and cash flow. In 1999 the group had income before interest and taxes (IBIT) of \$380 million, or 19 percent of Enron's overall IBIT. Natural gas pipelines and their storage facilities are a key component of Enron's energy strategy.

The Gas Pipeline Group is benefiting from the nation's growing demand for natural gas. Domestic gas consumption is expected to increase to almost 30 trillion cubic feet (Tcf) per year by 2010 from almost 23 Tcf at present. Much of that consumption is driven by the use of natural gas to fuel new electricity generation. Unlike industrial users, generators require more flexibility and choices in gas delivery. To meet the new demands of the market, we are expanding all systems to transport



more gas to more users, and providing those users with more flexible choices.

Perhaps more than any other pipeline operator, Enron's Gas Pipeline Group helps customers respond to shifting gas markets. Value-added products and services beyond transportation allow us to leverage our assets, build a knowledge-based business and keep our pipelines fully subscribed and running at capacity in the face of increased competition. We also operate with one of the lowest cost structures in the industry, which gives us a distinct advantage over competitors.

The expansion of our systems has been facilitated by Enron's regulatory, engineering and construction skills, which allow us to speed implementation.

The Gas Pipeline Group continues to be recognized for its superior environmental record. For the third year running, we won the Environmental Protection Agency's Star Program Transmission Partner of the Year award, the only gas transmission company to receive the award since its inception in 1997.

The Gas Pipeline Group operates four interstate pipelines that move approximately 9.2 billion cubic feet (Bcf) of gas daily: *Northern Natural Gas*

Northern Natural Gas is the largest system, with 16,463

miles of pipeline running from Texas to the Great Lakes, serving the upper Midwest. Deliveries averaged 3.8 Bcf per day in 1999. Since 1995, the system has increased market capacity by 10 percent.

With the proliferation of power plant development in its market, Northern Natural Gas is responding to the distinct needs of this new customer. Northern also continues to work with its Midwest-based customers to actively pursue and connect increased load requirements in this growing market by offering competitive transportation and storage products that connect these markets to a variety of alternative suppliers.

#### *Transwestern Pipeline*

Transwestern's 2,487 miles of pipe have bi-directional capability, allowing customers to direct gas to the best markets. Originating in the San Juan Basin, Transwestern can move gas east to Texas or west to the California border. Daily delivery averaged 1.5 Bcf in 1999.

In January 2000 Transwestern's Gallup expansion project was approved by the Federal Energy Regulatory Commission (FERC). The addition of one compressor station near Gallup, New

Mexico, and two coolers at the La Plata and Blanco Hub will increase capacity to the California border by 140 million cubic feet per day (MMcf/d).

#### *Florida Gas Transmission*

Florida Gas Transmission, the sole interstate natural gas pipeline serving peninsular Florida, is the fastest growing system in North America. With a surge in state population and demand for gas-fired electric generation, Florida Gas Transmission is working on two major expansions. Phase IV will

consist of pipe and compression to extend its network

to southwest Florida and add capacity of nearly 200 MMcf/d. This project is scheduled to be in service by mid-2001. The proposed Phase V expansion, once completed, will add approximately 400 MMcf/d of capacity and has an in-service date of 2002. The proposal was filed in December with FERC.

The 4,795-mile pipeline had average daily capacity of 1.5 Bcf in 1999.

#### *Northern Border Pipeline*

Northern Border Pipeline runs from the U.S./Canadian border in Montana to Illinois, transporting approximately 23 percent of all Canadian gas imports to the U.S. The pipeline measures 1,214 miles and averaged daily deliveries of 2.4 Bcf in 1999. The Chicago Project expansion was put in service at the end of 1998. By interconnecting with multiple pipeline systems, this link fundamentally changed North American markets by establishing a new relationship between Canadian and NYMEX gas prices. Northern Border has proposed a second expansion, Project 2000, to connect to Northern Indiana Public Service Company and its industrial customer base in the Midwest.

#### PORTLAND GENERAL ELECTRIC

In November, Sierra Pacific Resources agreed to purchase Portland General Electric for \$2.1 billion, including \$2.02 billion



in cash and the assumption of Enron's approximately \$80 million merger payment obligation. Sierra Pacific also will assume \$1 billion in PGE debt and preferred stock. The proposed transaction is expected to conclude in late 2000.

Enron purchased the utility in 1997 to enter the Pacific Northwest market. Through our association, we successfully launched a merchant services operation in that region and acquired Portland General Electric's communications business, which became the basis for Enron Broadband Services. The electricity market has advanced rapidly since that time, and we can now offer merchant energy services to customers without owning a regulated electric utility.

## *TRANSWESTERN PIPELINE*

Traditional gas transportation offers little flexibility to customers.

*ENRON ASKS WHY?*



**STRATEGY:** TRANSWESTERN USES ITS EXPERTISE AND ENRON'S TO FAST-TRACK CAPACITY EXPANSION

to California, where natural gas demand is growing rapidly. In response to customers' reluctance to subscribe to the new capacity under old scenarios, Transwestern Pipeline develops innovative, flexible products for the natural gas transportation market.

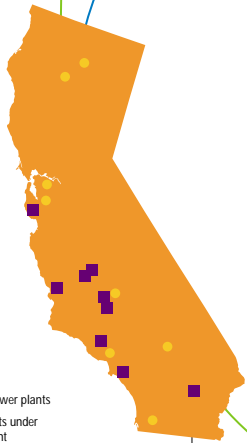

■ Planned power plants  
● Power plants under development

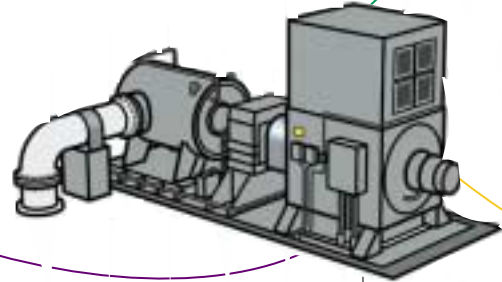

**TRANSWESTERN GAS FLOWS TASK FORCE**

Through its forecast of overall demand and supply of gas production in the U.S. and Canada, the task force anticipates that California gas demand will increase by 3.2 percent annually, mostly due to electric power generation. Customers want to ship low-cost gas from the San Juan basin in New Mexico to the California border. They sign commitments to use the proposed increase in Transwestern's capacity because of Transwestern's ability to offer innovative deal structures and its bi-directional flexibility to serve both California and Texas intrastate markets.

**TRANSWESTERN OPTIMIZATION TEAM**

Created to increase pipeline capacity through incremental improvements, the Optimization Team searches for ways to flow more gas without laying new pipe. To increase capacity 15 percent, Ben Asante, Ron Matthews, Terry Galassini and Dave Foti conceive an innovative two-step approach. First, the team will site a new \$12 million compressor at Gallup, New Mexico, to increase pressure at the San Juan junction to 950 psig. Second, it advocates the use of two coolers, at La Plata and the Blanco Hub, to reduce the gas temperature, allowing more gas to be compressed through the pipe.

**ENRON COMPRESSION SERVICES**

Enron provides compression services at several pipeline sites throughout North America. Enron will provide 10,000 shaft horsepower to run the Gallup compressor. By providing the service at a lower cost than Transwestern could otherwise obtain, Enron helps lower the cost of the Gallup expansion.

# TRANSWESTERN PIPELINE'S GALLUP EXPANSION PROJECT

**RESULT:** TRANSWESTERN INCREASES PIPELINE CAPACITY TO THE CALIFORNIA BORDER WITHOUT LAYING new pipe—avoiding delay, expense and rights-of-way negotiations. Capacity will increase 15 percent beginning second quarter 2000, just months after the plan is approved by federal regulators.

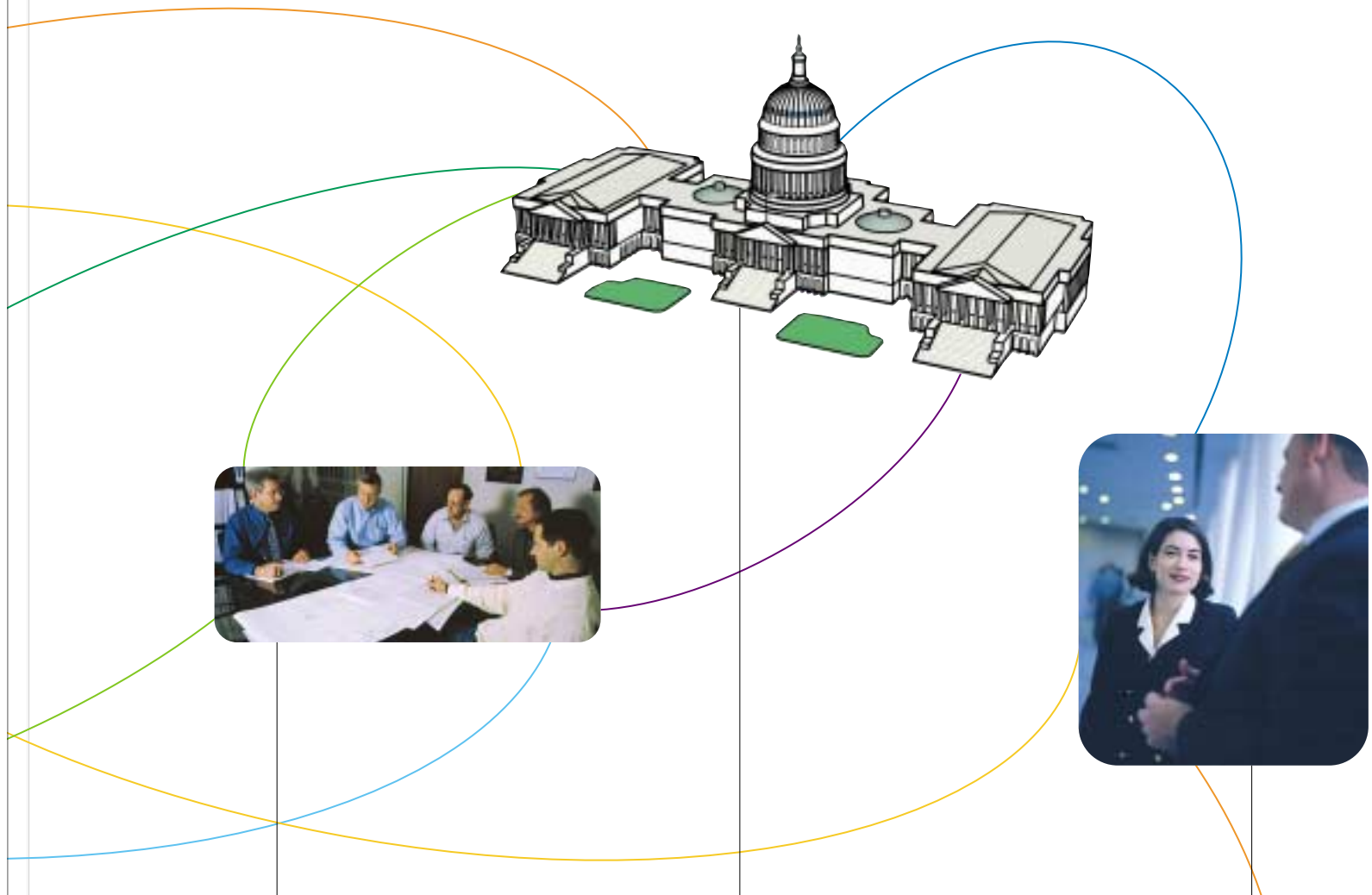

ENRON ENGINEERING & CONSTRUCTION COMPANY	TRANSWESTERN GOVERNMENT/REGULATORY AFFAIRS	TRANSWESTERN COMMERCIAL GROUP
<p>Enron Engineering &amp; Construction Company (EE&amp;C) is the traditional provider of construction services to Transwestern. EE&amp;C's familiarity with the project and Transwestern's system allows it to set an ambitious schedule of completing construction in just four months. When completed, the Gallup expansion will add 50 MMcf/d from the San Juan basin. Overall, Transwestern's capacity to the California border is anticipated to increase by 140 MMcf/d.</p>	<p>Transwestern files its expansion proposal with the Federal Energy Regulatory Commission (FERC) in May 1999. FERC approves the proposal in January 2000.</p>	<p>Transwestern creates customized products to meet the specific needs of its customers. They can purchase capacity at set prices or index the price of transportation to basin spreads. For the first time, customers can use a variety of Transwestern services to mitigate price risk.</p>

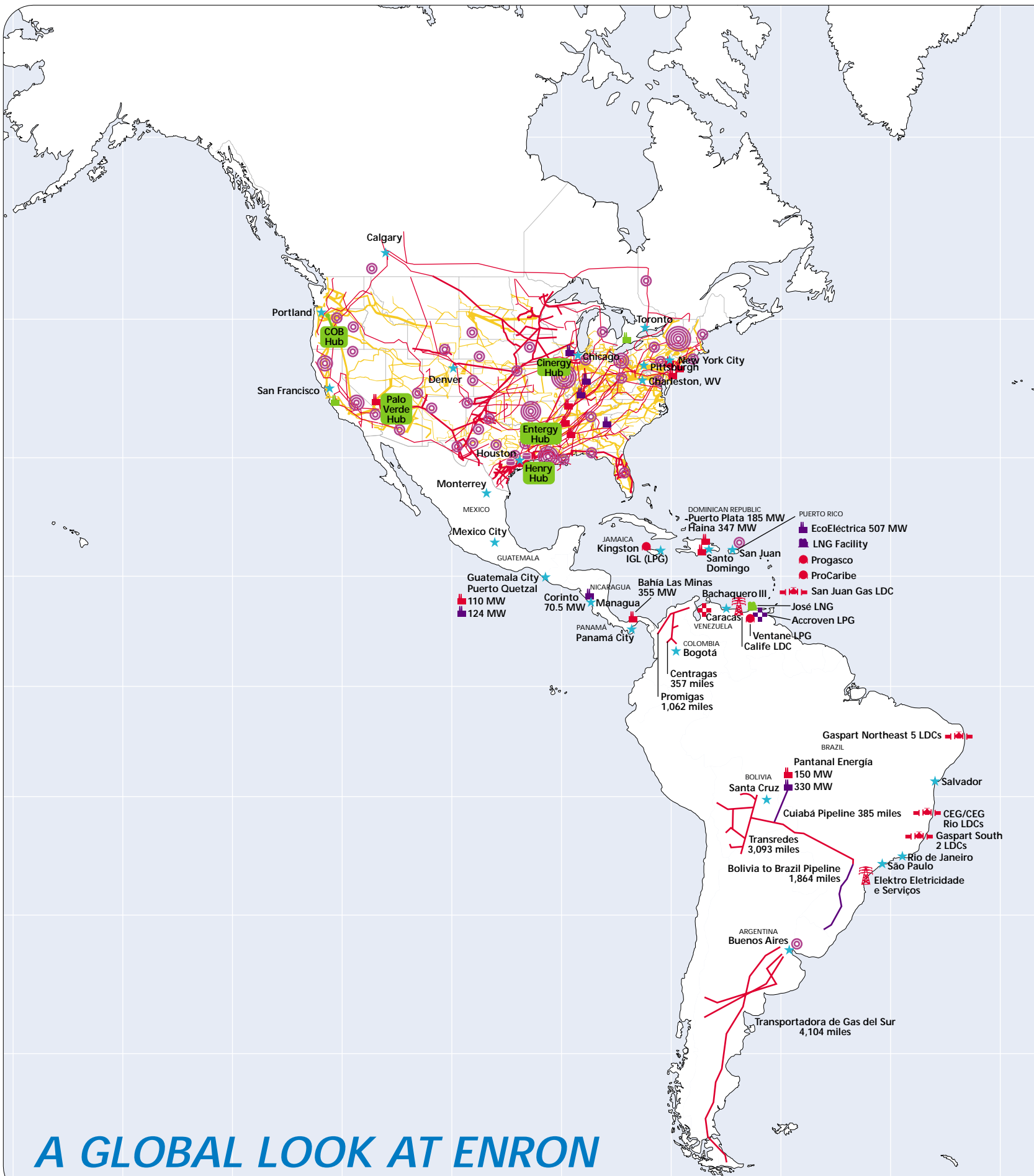

# A GLOBAL LOOK AT ENRON

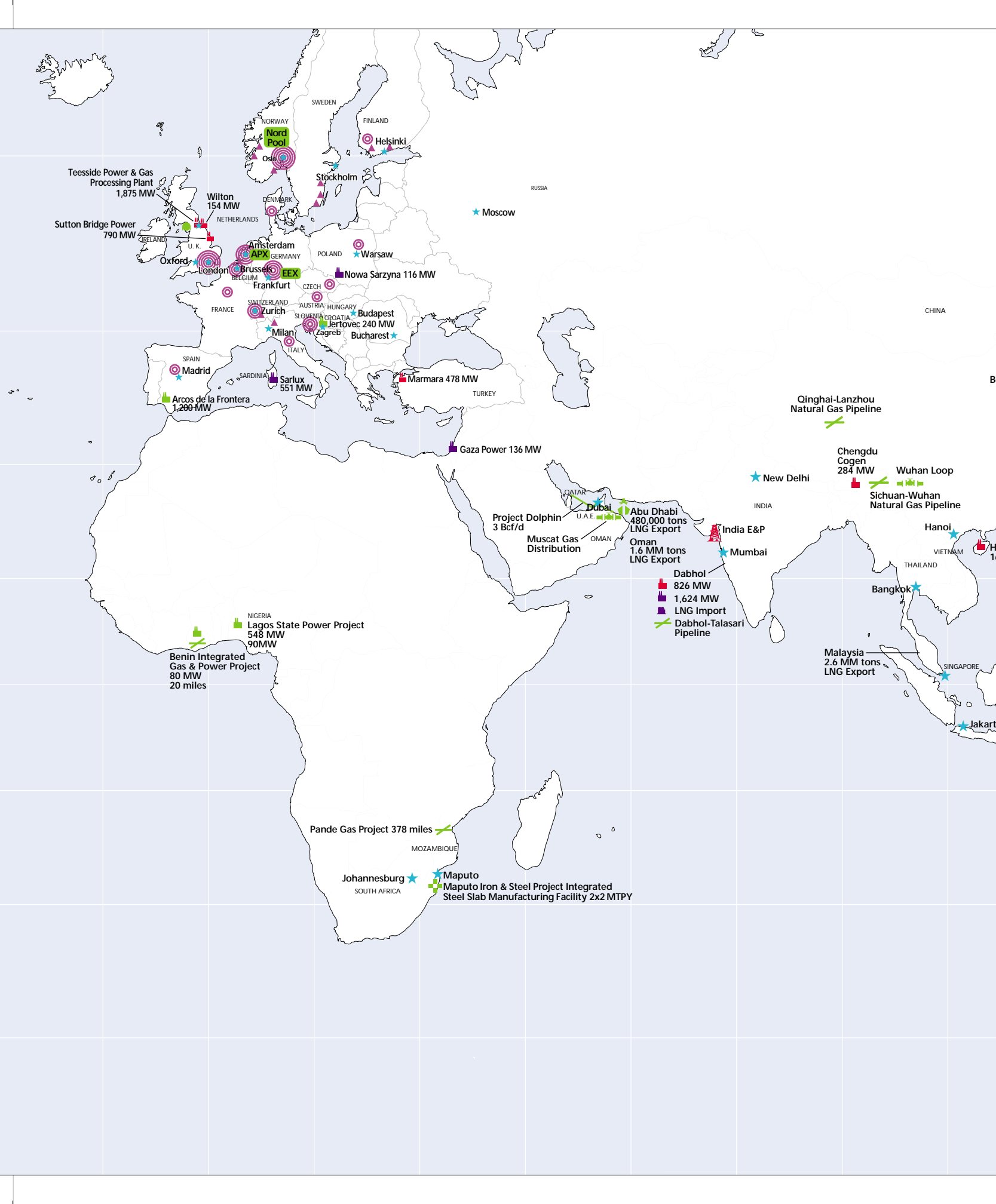

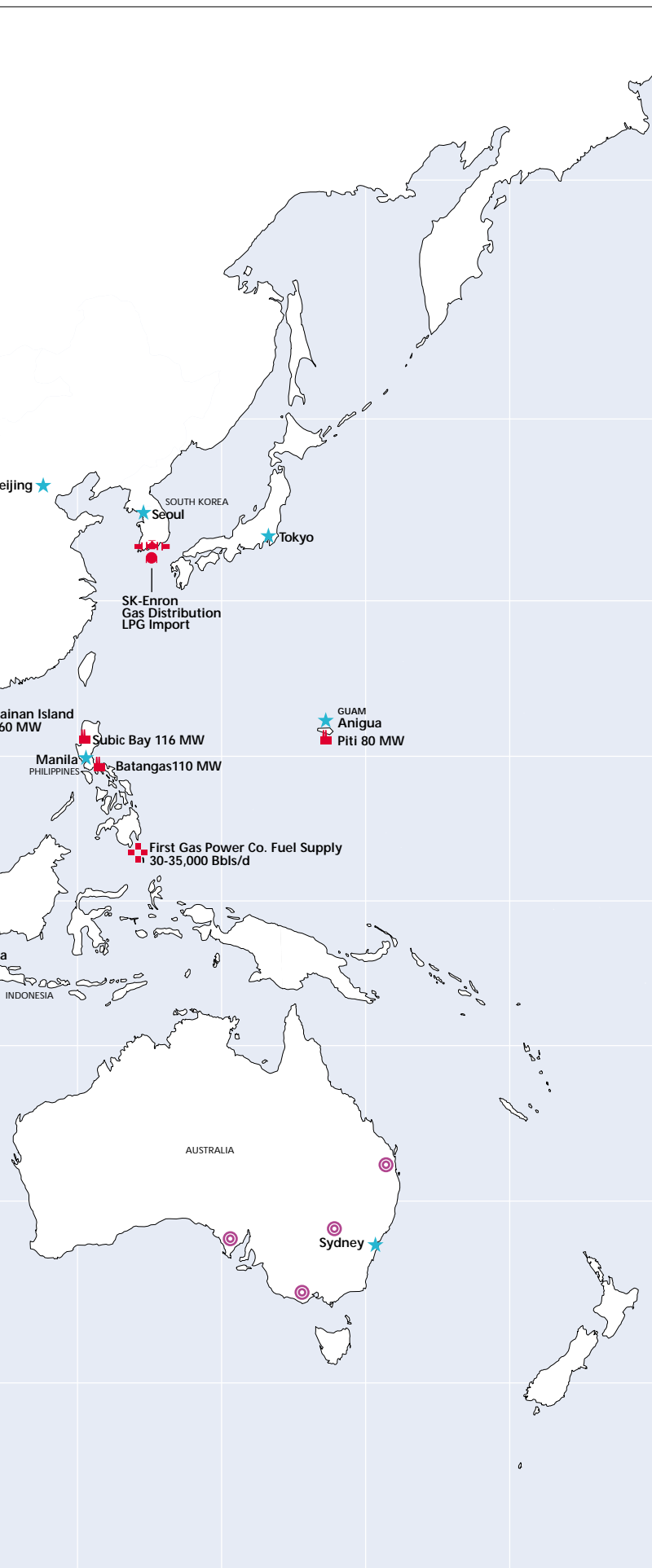

60°N  
45°N  
30°N  
15°N  
0°  
15°S  
30°S  
45°S

- ★ ENRON WHOLESAL E OFFICES
- TRADING EXCHANGE
- ✂ ELECTRIC GRID
- GAS PROCESSING PLANTS
- STORAGE FACILITIES
- ▲ ENERGY PARTNERS

**DAILY ENERGY MARKETING ACTIVITY (BBTUE/D)**

- ◎ 3000 +
- ◎ 2000 – 3000
- ◎ 1000 – 2000
- ◎ 0 – 1000

**PROJECTS OR GENERATION ASSETS IN OPERATION**

- POWER PLANT
- ✂ ENRON-OWNED PIPELINE
- ✂ LEASED PIPELINE CAPACITY
- ✂ OTHER
- LPG FACILITY
- ▲ E&P
- GAS DISTRIBUTION
- ▲ ELECTRICITY DISTRIBUTION

**PROJECTS OR GENERATION ASSETS IN CONSTRUCTION OR COMMISSION**

- POWER PLANT
- ✂ PIPELINE
- ✂ OTHER
- LPG FACILITY
- LNG FACILITY

**PROJECTS OR GENERATION ASSETS IN DEVELOPMENT**

- POWER PLANT
- ✂ PIPELINE
- GAS DISTRIBUTION
- LPG FACILITY
- LNG FACILITY
- ▲ LNG VESSEL
- ✂ OTHER

## The Enron Broadband Services Network

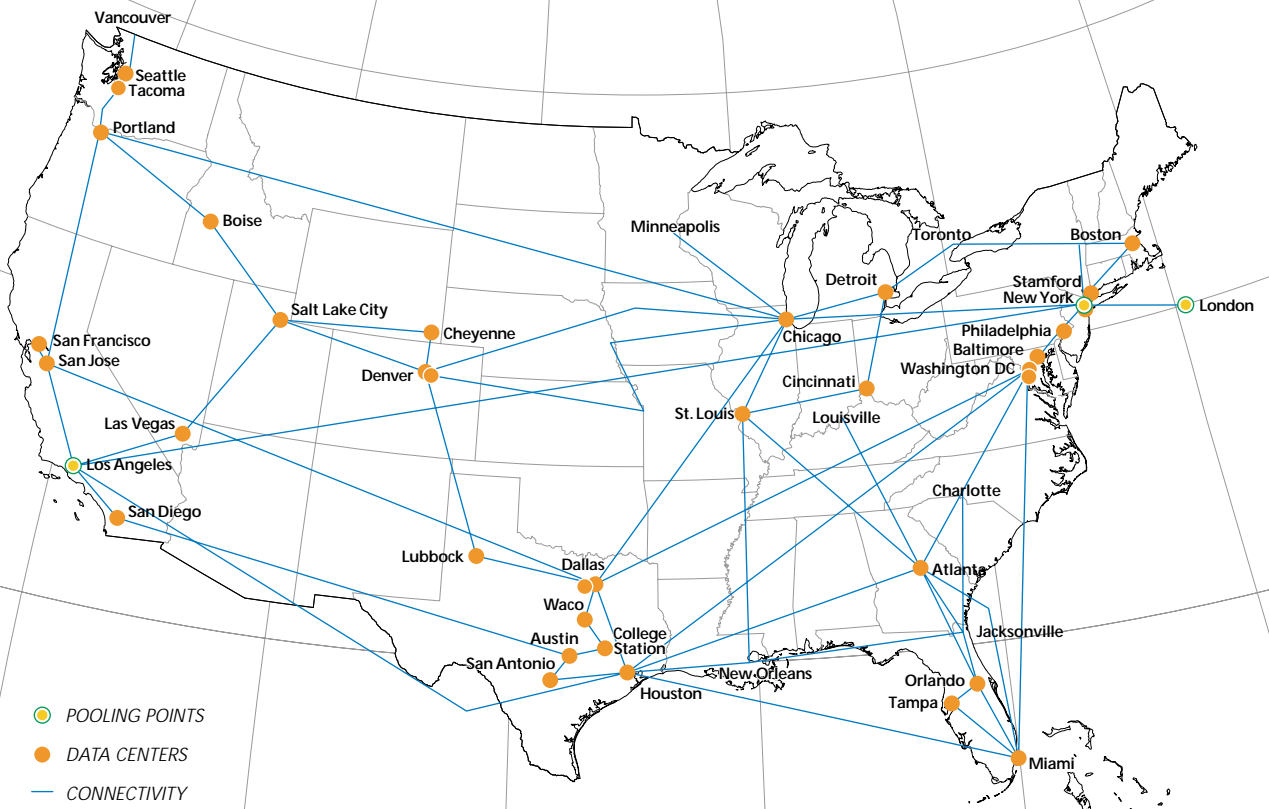

## The Retail Network's Portfolio of Nationwide Outsourcing Contracts

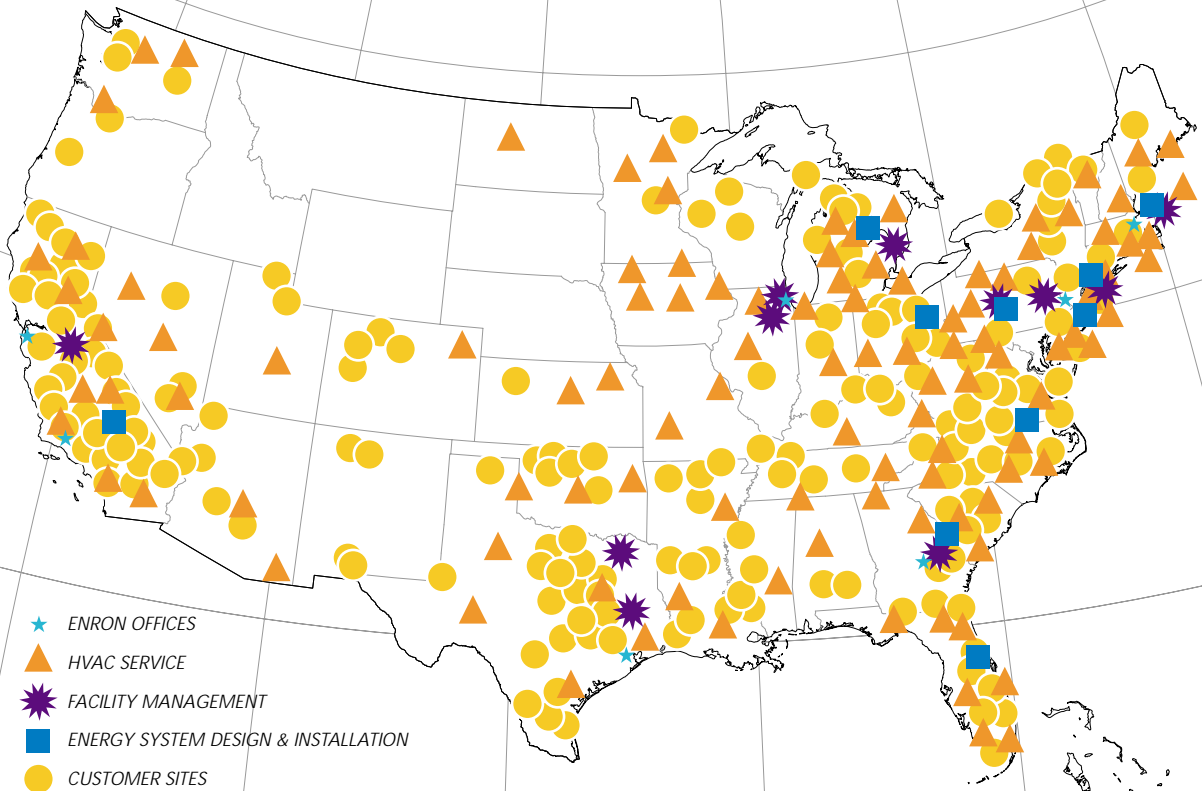

## CONTENTS

- 31 MANAGEMENT'S DISCUSSION AND ANALYSIS OF FINANCIAL CONDITION AND RESULTS OF OPERATIONS
- 37 FINANCIAL RISK MANAGEMENT
- 39 INFORMATION REGARDING FORWARD-LOOKING STATEMENTS
- 39 MANAGEMENT'S RESPONSIBILITY FOR FINANCIAL REPORTING
- 40 REPORTS OF INDEPENDENT PUBLIC ACCOUNTANTS
- 41 ENRON CORP. AND SUBSIDIARIES CONSOLIDATED INCOME STATEMENT
- 41 ENRON CORP. AND SUBSIDIARIES CONSOLIDATED STATEMENT OF COMPREHENSIVE INCOME
- 42 ENRON CORP. AND SUBSIDIARIES CONSOLIDATED BALANCE SHEET
- 44 ENRON CORP. AND SUBSIDIARIES CONSOLIDATED STATEMENT OF CASH FLOWS
- 45 ENRON CORP. AND SUBSIDIARIES CONSOLIDATED STATEMENT OF CHANGES IN SHAREHOLDERS' EQUITY
- 46 ENRON CORP. AND SUBSIDIARIES NOTES TO THE CONSOLIDATED FINANCIAL STATEMENTS
- 62 SELECTED FINANCIAL AND CREDIT INFORMATION (UNAUDITED)

# *FINANCIAL REVIEW*



## Management's Discussion and Analysis of Financial Condition and Results of Operations

The following review of the results of operations and financial condition of Enron Corp. and its subsidiaries and affiliates (Enron) should be read in conjunction with the Consolidated Financial Statements.

### RESULTS OF OPERATIONS

#### Consolidated Net Income

Enron's net income for 1999 was \$893 million compared to \$703 million in 1998 and \$105 million in 1997. Enron's operating segments include Transportation and Distribution (Gas Pipeline Group and Portland General), Wholesale Energy Operations and Services (Enron's North America, Europe and international energy businesses and Enron Broadband Services), Retail Energy Services (Enron Energy Services), Exploration and Production (Enron Oil & Gas Company) through August 16, 1999 (see Note 2 to the Consolidated Financial Statements), and Corporate and Other, which includes certain other businesses. Net income includes the following:

(In millions)	1999	1998	1997
After-tax results before items impacting comparability	\$ 957	\$ 698	\$ 515
Items impacting comparability: <sup>(a)</sup>			
Gains on sales of subsidiary stock	345	45	61
Charge to reflect impairment of MTBE assets	(278)	-	-
Charges to reflect losses on contracted MTBE production	-	(40)	(74)
Charge to reflect impact of amended J-Block gas contract	-	-	(463)
Gains on sales of liquids and gathering assets	-	-	66
Cumulative effect of accounting changes	(131)	-	-
<b>Net income</b>	<b>\$ 893</b>	<b>\$ 703</b>	<b>\$ 105</b>

(a) Tax affected at 35%, except where a specific tax rate applied.

Diluted earnings per share of common stock were as follows:

	1999	1998	1997
Diluted earnings per share <sup>(a)</sup> :			
After-tax results before items impacting comparability	\$1.18	\$1.00	\$0.87
Items impacting comparability:			
Gains on sales of subsidiary stock	0.45	0.07	0.11
Charge to reflect impairment of MTBE assets	(0.36)	-	-
Charges to reflect losses on contracted MTBE production	-	(0.06)	(0.13)
Charge to reflect impact of amended J-Block gas contract	-	-	(0.78)
Gains on sales of liquids and gathering assets	-	-	0.11
Cumulative effect of accounting changes	(0.17)	-	-
Effect of anti-dilution <sup>(b)</sup>	-	-	(0.02)
<b>Diluted earnings per share</b>	<b>\$1.10</b>	<b>\$1.01</b>	<b>\$0.16</b>

(a) Restated to reflect the two-for-one stock split effective August 13, 1999.

(b) For 1997, the conversion of preferred shares to common shares for purposes of the diluted earnings per share calculation was anti-dilutive by \$0.02 per share. However, in order to present comparable results, per share amounts for each earnings component were calculated using 592 million shares, which assumes the conversion of preferred shares to common shares.

### Income Before Interest, Minority Interests and Income Taxes

The following table presents income before interest, minority interests and income taxes (IBIT) for each of Enron's operating segments (see Note 20 to the Consolidated Financial Statements):

(In millions)	1999	1998	1997
Transportation and Distribution:			
Gas Pipeline Group	\$ 380	\$ 351	\$ 466
Portland General	305	286	114
Wholesale Energy Operations and Services	1,317	968	654
Retail Energy Services	(68)	(119)	(107)
Exploration and Production	65	128	183
Corporate and Other	(4)	(32)	(745)
Income before interest, minority interests and taxes	<b>\$1,995</b>	<b>\$1,582</b>	<b>\$ 565</b>

#### Transportation and Distribution

Transportation and Distribution consists of Enron's Gas Pipeline Group and Portland General. The Gas Pipeline Group includes Enron's interstate natural gas pipelines, primarily Northern Natural Gas Company (Northern), Transwestern Pipeline Company (Transwestern), Enron's 50% interest in Florida Gas Transmission Company (Florida Gas) and Enron's interests in Northern Border Pipeline and EOTT Energy Partners, L.P. (EOTT).

*Gas Pipeline Group.* The following table summarizes total volumes transported by each of Enron's interstate natural gas pipelines.

	1999	1998	1997
Total volumes transported (BBtu/d) <sup>(a)</sup>			
Northern Natural Gas	3,820	4,098	4,364
Transwestern Pipeline	1,462	1,608	1,416
Florida Gas Transmission	1,495	1,324	1,341
Northern Border Pipeline	2,405	1,770	1,800

(a) Billion British thermal units per day. Amounts reflect 100% of each entity's throughput volumes. Florida Gas and Northern Border Pipeline are unconsolidated equity affiliates.

Significant components of IBIT are as follows:

(In millions)	1999	1998	1997
Net revenues	\$626	\$640	\$665
Operating expenses	264	276	310
Depreciation and amortization	66	70	69
Equity earnings	38	32	40
Other income, net	46	25	38
IBIT before items impacting comparability	380	351	364
Gains on sales of liquids and gathering assets	-	-	102
<b>Income before interest and taxes</b>	<b>\$380</b>	<b>\$351</b>	<b>\$466</b>

#### Net Revenues

Revenues, net of cost of sales, of Gas Pipeline Group declined \$14 million (2%) during 1999 and \$25 million (4%) during 1998 as compared to the applicable preceding year. The decrease in net revenue in 1999 compared to 1998 was primarily a result of the expiration, in October 1998, of certain transition cost recovery surcharges, partially offset by a sale in 1999 of gas from Northern's gas storage inventory. The decrease in net revenue in 1998 compared to 1997 was primarily due to the warmer than normal winter in Northern's service territory and the reduction of transition costs recovered through a regulatory surcharge at Northern.

## Operating Expenses

Operating expenses, including depreciation and amortization, of Gas Pipeline Group declined \$16 million (5%) during 1999 primarily as a result of the expiration of certain transition cost recovery surcharges. Operating expenses decreased \$33 million (9%) during 1998 primarily as a result of the reduction of transition costs at Northern and lower overhead costs.

## Equity Earnings

Equity in earnings of unconsolidated equity affiliates increased \$6 million in 1999 after decreasing \$8 million during 1998 as compared to 1997. The increase in earnings in 1999 as compared to 1998 was primarily a result of higher earnings from Northern Border Pipeline and EOTT reflecting Northern Border Pipeline's expansion project and greater volumes transported by EOTT due to acquisitions made during the last year. The decrease during 1998 as compared to 1997 was primarily due to higher 1997 earnings from Citrus Corp. (Citrus), which holds Enron's 50% interest in Florida Gas. Earnings from Citrus were higher in 1997 due to a contract restructuring.

## Other Income, Net

Other income, net increased \$21 million in 1999 as compared to 1998 after decreasing \$13 million in 1998 as compared to 1997. Included in 1999 was interest income earned in connection with the financing of an acquisition by EOTT, while the 1998 amount included gains of \$21 million recognized from the sale of an interest in an equity investment, substantially offset by charges related to litigation.

*Portland General.* Results for Portland General have been included in Enron's Consolidated Financial Statements beginning July 1, 1997. Since that date, Portland General realized IBIT as follows:

(In millions)	1999	1998	1997(a)
Revenues	\$1,379	\$1,196	\$746
Purchased power and fuel	639	451	389
Operating expenses	304	295	154
Depreciation and amortization	181	183	91
Other income, net	50	19	2
Income before interest and taxes	\$ 305	\$ 286	\$114

(a) Represents the period from July 1, 1997 through December 31, 1997.

Revenues and purchased power and fuel costs increased \$183 million and \$188 million, respectively, in 1999 as compared to 1998. Revenues increased primarily as a result of an increase in the number of customers served by Portland General. Higher purchased power and fuel costs, which increased 42% in 1999, offset the increase in revenues. Other income, net increased \$31 million in 1999 as compared to 1998 primarily as a result of a gain recognized on the sale of certain assets.

The 1998 results were impacted by a warmer than normal winter and the transfer of the majority of Portland General's electricity wholesale business to the Enron Wholesale segment, partially offset by an increase in sales to retail customers.

Statistics for Portland General are as follows:

	1999	1998	1997(a)
Electricity sales (thousand MWh)(b)			
Residential	7,404	7,101	3,379
Commercial	7,392	6,781	3,618
Industrial	4,463	3,562	2,166
Total retail	19,259	17,444	9,163
Wholesale	12,612	10,869	13,448
Total electricity sales	31,871	28,313	22,611
Resource mix			
Coal	15%	16%	10%
Combustion turbine	8	12	5
Hydro	9	9	5
Total generation	32	37	20
Firm purchases	57	56	74
Secondary purchases	11	7	6
Total resources	100%	100%	100%
Average variable power cost (Mills/KWh)(c)			
Generation	9.8	8.6	8.7
Firm purchases	23.2	17.3	18.9
Secondary purchases	19.7	23.6	13.2
Total average variable power cost	19.5	15.6	17.2
Retail customers (end of period, thousands)	719	704	685

(a) Represents the period from July 1, 1997 through December 31, 1997.

(b) Thousand megawatt-hours.

(c) Mills (1/10 cent) per kilowatt-hour.

## Outlook

The Gas Pipeline Group should continue to provide stable earnings and cash flows during 2000, including steady growth over 1999 levels. Low operating costs, competitive rates and continued expansion opportunities enable the Gas Pipeline Group to continue to be a strong, efficient competitor in all markets. Transwestern will bring 140 MMcf/d of additional supply from the San Juan Basin and West Texas into California in 2000. Florida Gas is currently the only major pipeline serving the rapidly growing peninsular Florida market where the demand for power is expected to continue to increase. Florida Gas is seeking approval from the Federal Energy Regulatory Commission (FERC) to implement two expansions over the next two years and is expected to seek approval from the FERC for a third expansion in the near future, which will increase its capacity by 950 MMcf/d to meet the expected increase in natural gas demand by power plants. Northern Border Pipeline is seeking approval from the FERC for its 545 MMcf/d expansion into Indiana which is to be completed and in service within the next year.

On November 8, 1999, Enron announced that it had entered into an agreement to sell Portland General to Sierra Pacific Resources. The proposed transaction, which is subject to regulatory approval, is expected to close in late 2000. See Note 2 to the Consolidated Financial Statements.

## Wholesale Energy Operations and Services

Enron's wholesale business (Enron Wholesale) includes its wholesale energy businesses around the world, as well as its emerging broadband services business. Enron Wholesale operates in developed markets such as North America and Europe, as well as developing or newly deregulating markets including South America, India and Japan.

Enron builds its wholesale businesses through the creation of networks involving asset ownership, contractual access to third-party assets and market-making activities. Each market in which Enron Wholesale operates utilizes these components in a slightly different manner and is

at a different stage of development. This network strategy has enabled Enron Wholesale to establish a leading position in its markets. These activities are categorized into two business lines: (a) Commodity Sales and Services and (b) Assets and Investments. Often these activities are integrated into a bundled product offering for Enron's customers.

Enron Wholesale manages its portfolio of contracts and assets in order to maximize value, minimize the associated risks and provide overall liquidity. In doing so, Enron Wholesale uses portfolio and risk management disciplines, including offsetting or hedging transactions, to manage exposures to market price movements (commodities, interest rates, foreign currencies and equities). Additionally, Enron Wholesale manages its liquidity and exposure to third-party credit risk through monetization of its contract portfolio or third-party insurance contracts. Enron Wholesale also sells interests in certain investments and other assets to improve liquidity and overall return.

The following table reflects IBIT for each business line:

(In millions)	1999	1998	1997
Commodity sales and services	\$ 628	\$411	\$249
Assets and investments	850	709	565
Unallocated expenses	(161)	(152)	(160)
Income before interest, minority interests and taxes	\$1,317	\$968	\$654

The following discussion analyzes the contributions to IBIT for each business line.

**Commodity Sales and Services.** Enron Wholesale provides reliable commodity delivery and predictable pricing to its customers through forward contracts. This market-making activity includes the purchase, sale, marketing and delivery of natural gas, electricity, liquids and other commodities, as well as the management of Enron Wholesale's own portfolio of contracts. Enron Wholesale's market-making activity is facilitated through a network of capabilities including asset ownership. Accordingly, certain assets involved in the delivery of these services are included in this business (such as intrastate natural gas pipelines, power plants and gas storage facilities).

Enron Wholesale markets, transports and provides energy commodities as reflected in the following table (including intercompany amounts):

	1999	1998	1997
Physical volumes (BBtue/d) <sup>(a)(b)</sup>			
Gas:			
United States	8,982	7,418	7,654
Canada	4,398	3,486	2,263
Europe	1,549	1,243	660
Other	23	8	-
	14,952	12,155	10,577
Transport volumes	575	559	460
Total gas volumes	15,527	12,714	11,037
Crude oil	5,407	2,960	690
Liquids	753	610	987
Electricity <sup>(c)</sup>	10,742	11,024	5,256
Total physical volumes (BBtue/d)	32,429	27,308	17,970
Electricity volumes marketed (thousand MWh)			
United States	380,518	401,843	191,746
Europe	11,143	483	100
Other	433	46	-
Total	392,094	402,372	191,846
Financial settlements (notional, BBtue/d)	99,337	75,266	49,082

(a) Billion British thermal units equivalent per day.

(b) Includes third-party transactions by Enron Energy Services.

(c) Represents electricity volumes marketed, converted to BBtue/d.

Earnings from commodity sales and services increased \$217 million (53%) in 1999 as compared to 1998 reflecting strong results from the intermediation businesses in both North America and Europe, which include delivery of energy commodities and associated risk management products. Enron Wholesale strengthened its market share leadership position in the North American energy markets and continued to expand its presence in Europe, particularly on the Continent where wholesale markets began deregulation in early 1999. Enron Wholesale also successfully managed its overall portfolio of contracts, particularly in minimizing credit exposures utilizing third-party contracts. New product offerings in coal and pulp and paper markets also added favorably to the results. In late 1999, Enron Wholesale launched an Internet-based eCommerce system, EnronOnline, which allows wholesale customers to view Enron's real time pricing and to complete commodity transactions with Enron as principal, with no direct interaction. This capability has positively impacted transaction levels.

The earnings from commodity sales and services operations increased 65% in 1998 as compared to 1997, reflecting growing transaction levels during the period. Sales in North America increased significantly due to increased power marketing activities (over 100% increase in volumes), along with new and restructured long-term contracts. European activity declined during the year, primarily reflecting the effect of regulatory actions in the United Kingdom that impacted the market for natural gas.

**Assets and Investments.** Enron's Wholesale businesses make investments in various energy and communications-related assets as a part of its network strategy. Enron Wholesale either purchases the asset from a third party or develops and constructs the asset. In most cases, Enron Wholesale operates and manages such assets. Earnings from these investments principally result from operations of the assets or sales of ownership interests.

Additionally, Enron Wholesale invests in debt and equity securities of energy and communications-related businesses, which may also utilize Enron Wholesale's products and services. With these merchant investments, Enron's influence is much more limited relative to assets Enron develops or constructs. Earnings from these activities result from changes in the market value of the security. See Note 4 to the Consolidated Financial Statements for a summary of these investments.

Earnings from assets and investments increased \$141 million (20%) in 1999 as compared to 1998. During 1999, earnings from Enron Wholesale's energy-related assets increased, reflecting the operation of the Dabhol Power Plant in India, ownership in Elektro Eletricidade e Serviços S.A. (Elektro), a Brazilian electric utility (see Note 2 to the Consolidated Financial Statements) and assets in various other developing markets. Enron Wholesale's merchant investments increased in value during the year due to the expansion into certain communications investments, partially offset by a decline in the value of certain energy investments. In addition, Enron Wholesale's 1999 earnings increased due to activities related to building and optimizing its broadband fiber network, while gains on sales of energy assets declined.

Earnings from assets and investments increased 25% in 1998 as compared to 1997. This increase reflects earnings from the sale of interests in certain energy assets including power projects in Puerto Rico, Turkey, Italy and the United Kingdom, from which Enron Wholesale realized the value created during the development and construction phases. Increased development costs in emerging markets and lower earnings from merchant investments partially offset such increase. Some of these transactions involved securitizations in which Enron retained certain interests associated with the underlying assets.

**Unallocated Expenses.** Net unallocated expenses include rent, systems expenses and other support group costs.

## Outlook

Enron Wholesale plans to continue to expand its networks in each of its key energy markets, as well as the market for broadband services. Worldwide energy markets continue to grow as governments implement deregulation or privatization plans. The market for broadband services is expected to increase significantly as demand increases for high bandwidth applications such as video. Enron will continue to purchase or develop selected assets to expand its networks, as well as grow its portfolio of contracts providing access to third-party assets. The combination of growing markets and Enron Wholesale's highly developed market-making skills should continue to enhance market opportunities globally for Enron over the next several years.

As a result, Enron anticipates continued growth in Enron Wholesale during 2000. In the commodity sales and services business, volumes are expected to continue to increase as Enron Wholesale increases its transaction volume in the growing unregulated U.S. power market and in the rapidly expanding European gas and power markets. In addition, EnronOnline is expected to significantly add to transaction volume and profit opportunities in the coming year. In the assets and investments business, Enron Wholesale expects to continue to benefit from opportunities related to its assets and investments, including sales or restructurings of appreciated investments, and in providing capital to energy-intensive customers. Equity earnings from operations are expected to increase as a result of commencement of commercial operations of new power plants and pipeline projects in early 2000. At December 31, 1999, Enron Wholesale's domestic and international projects under construction included approximately 2,300 miles of pipelines and eleven power plants with a combined capacity of approximately 5,700 megawatts, in which Enron owns various interests.

Earnings from Enron Wholesale are dependent on the origination and completion of transactions, some of which are individually significant and which are impacted by market conditions, the regulatory environment and customer relationships. Enron Wholesale's transactions have historically been based on a diverse product portfolio, providing a solid base of earnings. Enron's strengths, including its ability to identify and respond to customer needs, access to extensive physical assets and its integrated product offerings, are important drivers of the expected continued earnings growth. In addition, significant earnings are expected from Enron Wholesale's commodity portfolio and investments, which are subject to market fluctuations. External factors, such as the amount of volatility in market prices, impact the earnings opportunity associated with Enron Wholesale's business. Risk related to these activities is managed using naturally offsetting transactions and hedge transactions. The effectiveness of Enron's risk management activities can have a material impact on future earnings. See "Financial Risk Management" for a discussion of market risk related to Enron Wholesale.

## Retail Energy Services

Enron Energy Services (Energy Services) is extending Enron's energy expertise and capabilities to end-use retail customers in the industrial and commercial business sectors to manage their energy requirements and reduce total energy costs. During 1999, Energy Services continued to expand its presence in the United States and entered the international market by setting up operations in Europe and establishing organizations in South America, Mexico and Canada.

Energy Services provides natural gas, electricity, liquids and other commodities to industrial and commercial customers located throughout the United States and the United Kingdom. In deregulated locations, Energy Services may either supply commodities directly to its customers or have the local utilities supply customers in a manner similar to regulated locations. Energy Services also provides outsourcing solutions to

customers for full energy management. This integrated product includes the management of commodity delivery, energy information and energy assets, and may include price risk management activities.

Energy Services recognized losses before interest, minority interests and taxes of \$68 million, \$119 million and \$107 million for 1999, 1998 and 1997, respectively. The results primarily reflect the costs associated with developing the commodity, capital and services capability to deliver on contracts signed to date. These costs were partially offset by increased earnings from higher gas and power sales in 1999 resulting from the origination of new contracts and from outsourcing contracts for energy management services signed in 1999.

## Outlook

During 2000, Energy Services anticipates continued growth in the demand for retail energy outsourcing solutions, both domestically and internationally. Energy Services will deliver these services to its existing customers, while continuing to expand its commercial and industrial customer base for total energy outsourcing. Energy Services also plans to continue integrating its service delivery capabilities, focusing on the development of best practices, nationwide procurement opportunities and efficient use of capital.

## Exploration and Production

Enron's exploration and production operations have been conducted by Enron Oil & Gas Company (EOG). The operating results of this segment reflect activity through August 16, 1999, the date of the share exchange transaction with EOG (see Note 2 to the Consolidated Financial Statements).

Exploration and Production's 1999 IBIT of \$65 million reflected increased depreciation, depletion and amortization and operating expenses for the period through August 16, 1999, partially offset by decreased exploration expenses. Exploration and Production's 1998 IBIT decreased \$55 million as compared to 1997 primarily as a result of decreased wellhead natural gas, crude oil and condensate prices, higher operating and exploration expenses and depreciation, depletion and amortization, partially offset by increased production volumes.

## Corporate and Other

Corporate and Other includes results of Azurix Corp., which provides water and wastewater services, Enron Renewable Energy Corp. (EREC), which develops and constructs wind-generated power projects, and the operations of Enron's methanol and MTBE plants. Significant components of IBIT are as follows:

(In millions)	1999	1998	1997
IBIT before items impacting comparability	\$ (17)	\$ 7	\$ (31)
Items impacting comparability:			
Gain on sale of 7% of Enron Energy Services shares	-	-	61
Gains on exchange and sales of Enron Oil & Gas Company stock	454	22	-
Charge to reflect losses on contracted MTBE production	-	(61)	(100)
Charge to reflect impairment of MTBE assets	(441)	-	-
Charge to reflect impact of amended J-Block gas contract	-	-	(675)
Income before interest, minority interests and taxes	\$ (4)	\$(32)	\$(745)

Results for Corporate and Other in 1999 were impacted by higher corporate expenses, partially offset by increased earnings from EREC resulting from increased sales volumes from its German manufacturing subsidiary and from the completion and sale of certain domestic wind projects. Enron also recognized higher earnings related to Azurix.

Results in 1998 were favorably impacted by increases in the market value of certain corporate-managed financial instruments, partially offset by higher corporate expenses.

Items impacting comparability in 1999 include a pre-tax gain of \$454 million on the exchange and sale of Enron's interest in EOG (see Note 2 to the Consolidated Financial Statements) and a \$441 million pre-tax charge for the impairment of its MTBE assets (see Note 17 to the Consolidated Financial Statements).

During 1998, Enron recognized a pre-tax gain of \$22 million on the delivery of 10.5 million shares of EOG stock held by Enron as repayment of mandatorily exchangeable debt. Enron also recorded a \$61 million charge to reflect losses on contracted MTBE production.

During 1997, Enron recorded a non-recurring charge of \$675 million, primarily reflecting the impact of Enron's amended J-Block gas contract in the U.K., and a \$100 million charge to reflect losses on contracted MTBE production. Also in 1997, Enron sold approximately 7% of its ownership of Energy Services for \$130 million and recognized an after-tax gain of \$61 million.

## Interest and Related Charges, Net

Interest and related charges, net of interest capitalized, increased to \$656 million in 1999 from \$550 million in 1998 and \$401 million in 1997. The increase in 1999 as compared to 1998 was primarily due to debt issuances and debt related to Elektro, partially offset by a decrease in debt related to EOG following the sale and exchange of Enron's interests in August 1999. See Note 2 to the Consolidated Financial Statements.

The increase in 1998 as compared to 1997 was primarily a result of higher debt levels, including debt issuances and the consolidation in July 1997 of debt related to Portland General (see Note 2 to the Consolidated Financial Statements).

Interest capitalized, which totaled \$54 million, \$66 million and \$18 million for 1999, 1998, and 1997, respectively, increased in 1998 as a result of the commencement of construction of several power projects.

## Dividends on Company-Obligated Preferred Securities of Subsidiaries

Dividends on company-obligated preferred securities of subsidiaries increased from \$69 million in 1997 to \$77 million in 1998 and \$76 million in 1999, primarily due to the issuance of \$372 million of additional preferred securities by Enron subsidiaries during 1997. Company-obligated preferred securities of subsidiaries also increased by \$29 million in 1997 for securities of Portland General.

## Minority Interests

Minority interests include the following:

(In millions)	1999	1998	1997
Jacaré Electrical Distribution Trust	\$ 39	\$ -	\$ -
Majority-owned limited partnerships	71	-	-
Whitewing Associates, L.P.	12	53	-
Enron Oil & Gas Company	2	24	56
Enron Global Power & Pipelines L.L.C.	-	-	24
Other	11	-	-
	\$135	\$77	\$80

Minority interests include Jacaré beginning January 1, 1999, majority-owned limited partnerships since their formation in December 1998 and July 1999, Whitewing from its formation in December 1997 until its deconsolidation in March 1999, EOG until the exchange and sale of Enron's interests in August 1999 and Enron Global Power & Pipelines L.L.C. until Enron acquired the minority interest in November 1997 (see Notes 2, 8 and 9 to the Consolidated Financial Statements).

## Income Tax Expense

Income tax expense decreased in 1999 compared to 1998 primarily as a result of increased equity earnings, tax benefits related to the foreign tax rate differential and the audit settlement related to Monthly Income Preferred Shares, partially offset by increased earnings.

Income tax expense increased in 1998 as compared to 1997 primarily as a result of increased earnings, partially offset by differences between the book and tax basis of certain assets and stock sales.

## Cumulative Effect of Accounting Changes

In the first quarter of 1999, Enron recorded an after-tax charge of \$131 million to reflect the initial adoption (as of January 1, 1999) of two new accounting pronouncements, the AICPA Statement of Position 98-5 (SOP 98-5), "Reporting on the Costs of Start-Up Activities," and the Emerging Issues Task Force Issue No. 98-10, "Accounting for Contracts Involved in Energy Trading and Risk Management Activities." The first quarter 1999 charge was primarily related to the adoption of SOP 98-5. See Note 18 to the Consolidated Financial Statements.

## YEAR 2000

A Year 2000 problem was anticipated which could have resulted from the use in computer hardware and software of two digits rather than four digits to define the applicable year. The use of two digits was a common practice for decades when computer storage and processing was much more expensive than today. When computer systems must process dates both before and after January 1, 2000, two-digit year "fields" may create processing ambiguities that can cause errors and system failures. For example, computer programs that have date-sensitive features may recognize a date represented by "00" as the year 1900 instead of 2000.

The Year 2000 problem has caused no material disruption to Enron's mission-critical facilities or operations, and resulted in no material costs. Enron will remain vigilant for Year 2000 related problems that may yet occur due to hidden defects in computer hardware or software at Enron or Enron's mission-critical external entities. Enron anticipates that the Year 2000 problem will not create material disruptions to its mission-critical facilities or operations, and will not create material costs.

## NEW ACCOUNTING PRONOUNCEMENTS

In June 1998, the Financial Accounting Standards Board (FASB) issued Statement of Financial Accounting Standards (SFAS) No. 133, "Accounting for Derivative Instruments and Hedging Activities." See Note 18 to the Consolidated Financial Statements.

## FINANCIAL CONDITION

### Cash Flows

(In millions)	1999	1998	1997
Cash provided by (used in):			
Operating activities	\$ 1,228	\$ 1,640	\$ 211
Investing activities	(3,507)	(3,965)	(2,146)
Financing activities	2,456	2,266	1,849

Net cash provided by operating activities decreased \$412 million in 1999, primarily reflecting increases in working capital and net assets from price risk management activities, partially offset by increased earnings and higher proceeds from sales of merchant assets and investments. The increase of \$1,429 million in 1998 reflects positive operating cash flow from Enron's major business segments, proceeds from sales of interests in energy-related merchant assets and cash from timing and other changes related to Enron's commodity portfolio, partially offset by new investments in merchant assets and investments. See Note 4 to the Consolidated Financial Statements.

Net cash used in investing activities primarily reflects capital expenditures and equity investments, which total \$3,085 million in 1999, \$3,564 million in 1998 and \$2,092 million in 1997. See "Capital Expenditures and Equity Investments" below. Partially offsetting these uses of cash were proceeds from the sales of non-merchant assets totaling \$294 million in 1999, \$239 million in 1998 and \$473 million in 1997. Proceeds in 1997 were primarily from sales of liquids assets.

Cash provided by financing activities in 1999 included \$1,504 million from the net issuance of short- and long-term debt, \$852 million from the issuance of common stock and \$568 million from the formation of majority-owned limited partnerships, partially offset by payments of \$467 million for dividends. Cash provided by financing activities in 1998 included \$875 million from the net issuance of short- and long-term debt, \$867 million from the issuance of common stock and \$828 million primarily from the sale of a minority interest in a subsidiary, partially offset by payments of \$414 million for dividends. Cash provided by financing activities

in 1997 was generated from net issuances of \$1,674 million of short- and long-term debt, \$372 million of preferred securities by subsidiary companies and \$555 million of subsidiary equity. These inflows were partially offset by payments of \$354 million for cash dividends and \$422 million for treasury stock.

### Capital Expenditures and Equity Investments

Capital expenditures by operating segment are as follows:

(In millions)	2000			
	Estimate	1999	1998	1997
Transportation and Distribution	\$ 287	\$ 316	\$ 310	\$ 337
Wholesale Energy Operations and Services	1,517	1,216	706	318
Retail Energy Services	47	64	75	36
Exploration and Production	-	226	690	626
Corporate and Other	35	541	124	75
Total	\$1,886	\$2,363	\$1,905	\$1,392

Capital expenditures increased \$458 million in 1999 and \$513 million in 1998 as compared to the previous year. During 1999, Enron Wholesale expenditures increased due primarily to construction of domestic and international power plants and the Enron Broadband Services fiber optic network. The 1999 increase in Corporate and Other reflects the purchase of certain previously leased MTBE-related assets. During 1998, Enron Wholesale expenditures increased primarily related to domestic and international power plant construction.

Cash used for investments in equity affiliates by the operating segments is as follows:

(In millions)	1999	1998	1997
Transportation and Distribution	\$ -	\$ 27	\$ 3
Wholesale Energy Operations and Services	712	703	580
Corporate and Other	10	929	117
Total	\$722	\$1,659	\$700

Equity investments in 1999 relate primarily to projects in Korea and India. Equity investments increased in 1998 as compared to 1997 primarily due to the acquisitions of Elektro and Wessex, net of proceeds from transactions reducing Enron's interests in these investments. See Notes 2 and 9 to the Consolidated Financial Statements.

The level of spending for capital expenditures and equity investments will vary depending upon conditions in the energy and broadband markets, related economic conditions and identified opportunities. Management expects that the capital spending program will be funded by a combination of internally generated funds, proceeds from dispositions of selected assets and short- and long-term borrowings.

### Working Capital

At December 31, 1999, Enron had working capital of \$496 million. If a working capital deficit should occur, Enron has credit facilities in place to fund working capital requirements. At December 31, 1999, those credit lines provided for up to \$3.0 billion of committed and uncommitted credit, of which \$125 million was outstanding. Certain of the credit agreements contain prefunding covenants. However, such covenants are not expected to restrict Enron's access to funds under these agreements. In addition, Enron sells commercial paper and has agreements to sell trade accounts receivable, thus providing financing to meet seasonal working capital needs. Management believes that the sources of funding described above are sufficient to meet short- and long-term liquidity needs not met by cash flows from operations.

Total capitalization at December 31, 1999 was \$21.2 billion. Debt as a percentage of total capitalization decreased to 38.5% at December 31, 1999 as compared to 41.9% at December 31, 1998. The decrease primarily reflects the issuance in February 1999 of approximately 27.6 million shares of common stock, a net increase in minority interests and increased preferred stock outstanding following the deconsolidation of Whitewing Associates, L.P. (see Note 10 to the Consolidated Financial Statements), partially offset by increased debt levels and a decrease in equity due to the devaluation of the Brazilian real (see Note 2 to the Consolidated Financial Statements).

Enron is a party to certain financial contracts which contain provisions for early settlement in the event of a significant market price decline in which Enron's common stock falls below certain levels (prices ranging from \$15.48 to \$28.00 per share) or if the credit ratings for Enron's unsecured, senior long-term debt obligations fall below investment grade. The impact of this early settlement could include the issuance of additional shares of Enron common stock.

Enron's senior unsecured long-term debt is currently rated BBB+ by Standard & Poor's Corporation and Baa2 by Moody's Investor Services. Enron's continued investment grade status is critical to the success of its wholesale businesses as well as its ability to maintain adequate liquidity. Enron's management believes it will be able to maintain or improve its credit rating.

## Financial Risk Management

Enron Wholesale offers price risk management services primarily related to commodities associated with the energy sector (natural gas, electricity, crude oil and natural gas liquids). Energy Services also offers price risk management services to its commercial and industrial customers. These services are provided through a variety of financial instruments including forward contracts, which may involve physical delivery of an energy commodity, swap agreements, which may require payments to (or receipt of payments from) counterparties based on the differential between a fixed and variable price for the commodity, options and other contractual arrangements. Interest rate risks and foreign currency risks associated with the fair value of its energy commodities portfolio are managed using a variety of financial instruments, including financial futures, swaps and options.

Enron's other businesses also enter into forwards, swaps and other contracts primarily for the purpose of hedging the impact of market fluctuations on assets, liabilities, production or other contractual commitments. Changes in the market value of these hedge transactions are deferred until the gain or loss is recognized on the hedged item.

Enron manages market risk on a portfolio basis, subject to parameters established by its Board of Directors. Market risks are monitored by an independent risk control group operating separately from the units that create or actively manage these risk exposures to ensure compliance with Enron's stated risk management policies. Enron's fixed price commodity contract portfolio is typically balanced to within an annual average of 1% of the total notional physical and financial transaction volumes marketed.

### Market Risk

The use of financial instruments by Enron's businesses may expose Enron to market and credit risks resulting from adverse changes in commodity and equity prices, interest rates and foreign exchange rates. For Enron Wholesale's and Energy Services' businesses, the major market risks are discussed below:

*Commodity Price Risk.* Commodity price risk is a consequence of providing price risk management services to customers as well as owning and operating production facilities. As discussed above, Enron actively manages this risk on a portfolio basis to ensure compliance with Enron's stated risk management policies. Forwards, futures, swaps and options are utilized to manage Enron's consolidated exposure to price fluctuations related to production from its production facilities.

*Interest Rate Risk.* Interest rate risk is also a consequence of providing price risk management services to customers and having variable rate debt obligations, as changing interest rates impact the discounted value of future cash flows. Enron utilizes forwards, futures, swaps and options to manage its interest rate risk.

*Foreign Currency Exchange Rate Risk.* Foreign currency exchange rate risk is the result of Enron's international operations and price risk management services provided to its worldwide customer base. The primary purpose of Enron's foreign currency hedging activities is to protect against the volatility associated with foreign currency purchase and sale transactions. Enron primarily utilizes forward exchange contracts, futures and purchased options to manage Enron's risk profile.

*Equity Risk.* Equity risk arises primarily from the assets and investments operations of Enron Wholesale, which provides capital to customers through equity participations in various investment activities. Enron generally manages this risk by hedging specific investments using futures, forwards, swaps and options.

Enron evaluates, measures and manages the market risk in its investments on a daily basis utilizing value at risk and other methodologies. The quantification of market risk using value at risk provides a consistent measure of risk across diverse markets and products. The use of these methodologies requires a number of key assumptions including the selection of a confidence level for expected losses, the holding period for liquidation and the treatment of risks outside the value at risk methodologies, including liquidity risk and event risk. Value at risk represents an estimate of reasonably possible net losses in earnings that would be recognized on its investments assuming hypothetical movements in future market rates and no change in positions. Value at risk is not necessarily indicative of actual results which may occur.

#### Value at Risk

Enron has performed an entity-wide value at risk analysis of virtually all of Enron's financial assets and liabilities. Value at risk incorporates numerous variables that could impact the fair value of Enron's investments, including commodity prices, interest rates, foreign exchange rates, equity prices and associated volatilities, as well as correlation within and across these variables. Enron estimates value at risk commodity, interest rate and foreign exchange exposures using a model based on Monte Carlo simulation of delta/gamma positions which captures a significant portion of the exposure related to option positions. The value at risk for equity exposure discussed above is based on J.P. Morgan's RiskMetrics™ approach. Both value at risk methods utilize a one-day holding period and a 95% confidence level. Cross-commodity correlations are used as appropriate.

The use of value at risk models allows management to aggregate risks across the company, compare risk on a consistent basis and identify the drivers of risk. Because of the inherent limitations to value at risk, including the use of delta/gamma approximations to value options, subjectivity in the choice of liquidation period and reliance on historical data to calibrate the models, Enron relies on value at risk as only one component in its risk control process. In addition to using value at risk measures, Enron performs regular stress and scenario analyses to estimate the economic impact of sudden market moves on the value of its portfolios. The results of the stress testing, along with the professional judgment of experienced business and risk managers, are used to supplement the value at risk methodology and capture additional market-related risks, including volatility, liquidity and event, concentration and correlation risks.

The following table illustrates the value at risk for each component of market risk:

(In millions)	December 31,		Year ended December 31, 1999		
	1999	1998	Average <sup>(a)</sup>	High Valuation <sup>(a)</sup>	Low Valuation <sup>(a)</sup>
<b>Trading Market Risk:</b>					
Commodity price	\$21	\$20	\$24	\$37 <sup>(b)</sup>	\$16
Interest rate	-	-	-	-	-
Foreign currency exchange rate	-	-	-	-	-
Equity <sup>(c)</sup>	26	12	20	29	14
<b>Non-Trading Market Risk<sup>(d)</sup>:</b>					
Commodity price <sup>(e)</sup>	1	10	8	18	1
Interest rate	2	-	2	2	1
Foreign currency exchange rate	4	-	3	5	-
Equity	3	-	-	3	-

(a) The average value presents a twelve month average of the month-end values. The high and low valuations for each market risk component represent the highest and lowest month-end value during 1999.

(b) In June 1999, seasonal dynamics in the U.S. power markets caused Enron's value at risk to increase significantly.

(c) Enron's equity trading market risk primarily relates to merchant activities (see Note 4 to the Consolidated Financial Statements). The increase in value at risk in 1999 is due primarily to greater volatility in investments held throughout 1999, increased levels of more volatile communications investments and further refinement of Enron's value at risk model to allow the inclusion of certain partnership interests and other instruments for the first time.

(d) Includes only the risk related to the financial instruments that serve as hedges and does not include the related underlying hedged item.

(e) Enron's hedging activity decreased following the exchange and sale of Enron's interest in EOG (see Note 2 to the Consolidated Financial Statements).

#### Accounting Policies

Accounting policies for price risk management and hedging activities are described in Note 1 to the Consolidated Financial Statements.



## *Information Regarding Forward-Looking Statements*

This Annual Report includes forward-looking statements within the meaning of Section 27A of the Securities Act of 1933 and Section 21E of the Securities Exchange Act of 1934. All statements other than statements of historical facts contained in this document are forward-looking statements. Forward-looking statements include, but are not limited to, statements relating to expansion opportunities for the Gas Pipeline Group, demand in the market for broadband services and high bandwidth applications, transaction volumes in the U.S. power market, commencement of commercial operations of new power plants and pipeline projects and growth in the demand for retail energy outsourcing solutions. When used in this document, the words "anticipate," "believe," "estimate," "expect," "intend," "may," "project," "plan," "should" and similar expressions are intended to be among the statements that identify forward-looking statements. Although Enron believes that its expectations reflected in these forward-looking statements are based on reasonable assumptions, such statements involve risk and uncertainties and no assurance can be given that actual results will be consistent with these forward-looking statements. Important factors that could cause actual results to differ materially from those in the forward-looking statements herein include political developments in foreign countries; the ability of Enron to penetrate new retail natural gas and electricity markets (including energy outsourcing markets) in the United States and Europe; the ability to penetrate the broadband services market; the timing and extent of deregulation of energy markets in the United States and in foreign jurisdictions; other regulatory developments in the United States and in foreign countries, including tax legislation and regulations; the extent of efforts by governments to privatize natural gas and electric utilities and other industries; the timing and extent of changes in commodity prices for crude oil, natural gas, electricity, foreign currency and interest rates; the extent of success in acquiring oil and gas properties and in discovering, developing, producing and marketing reserves; the timing and success of Enron's efforts to develop international power, pipeline and other infrastructure projects; the effectiveness of Enron's risk management activities; the ability of counterparties to financial risk management instruments and other contracts with Enron to meet their financial commitments to Enron; the effectiveness of Enron's Year 2000 Plan and the Year 2000 readiness of outside entities; and Enron's ability to access the capital markets and equity markets during the periods covered by the forward-looking statements, which will depend on general market conditions and Enron's ability to maintain or increase the credit ratings for its unsecured senior long-term debt obligations.

## *Management's Responsibility for Financial Reporting*

The following financial statements of Enron Corp. and subsidiaries (collectively, Enron) were prepared by management, which is responsible for their integrity and objectivity. The statements have been prepared in conformity with generally accepted accounting principles and necessarily include some amounts that are based on the best estimates and judgments of management.

The system of internal controls of Enron is designed to provide reasonable assurance as to the reliability of financial statements and the protection of assets from unauthorized acquisition, use or disposition. This system is augmented by written policies and guidelines and the careful selection and training of qualified personnel. It should be recognized, however, that there are inherent limitations in the effectiveness of any system of internal control. Accordingly, even an effective internal control system can provide only reasonable assurance with respect to the preparation of reliable financial statements and safeguarding of assets. Further, because of changes in conditions, internal control system effectiveness may vary over time.

Enron assessed its internal control system as of December 31, 1999, 1998 and 1997, relative to current standards of control criteria. Based upon this assessment, management believes that its system of internal controls was adequate during the periods to provide reasonable assurance as to the reliability of financial statements and the protection of assets against unauthorized acquisition, use or disposition.

Arthur Andersen LLP was engaged to audit the financial statements of Enron and issue reports thereon. Their audits included developing an overall understanding of Enron's accounting systems, procedures and internal controls and conducting tests and other auditing procedures sufficient to support their opinion on the financial statements. Arthur Andersen LLP was also engaged to examine and report on management's assertion about the effectiveness of Enron's system of internal controls. The Reports of Independent Public Accountants appear in this Annual Report.

The adequacy of Enron's financial controls and the accounting principles employed in financial reporting are under the general oversight of the Audit Committee of Enron Corp.'s Board of Directors. No member of this committee is an officer or employee of Enron. The independent public accountants have direct access to the Audit Committee, and they meet with the committee from time to time, with and without financial management present, to discuss accounting, auditing and financial reporting matters.

## Reports of Independent Public Accountants

To the Shareholders and Board of Directors of Enron Corp.:

We have examined management's assertion that the system of internal control of Enron Corp. (an Oregon corporation) and subsidiaries as of December 31, 1999, 1998 and 1997 was adequate to provide reasonable assurance as to the reliability of financial statements and the protection of assets from unauthorized acquisition, use or disposition, included in the accompanying report on Management's Responsibility for Financial Reporting. Management is responsible for maintaining effective internal control over the reliability of financial statements and the protection of assets against unauthorized acquisition, use or disposition. Our responsibility is to express an opinion on management's assertion based on our examination.

Our examinations were made in accordance with attestation standards established by the American Institute of Certified Public Accountants and, accordingly, included obtaining an understanding of the system of internal control, testing and evaluating the design and operating effectiveness of the system of internal control and such other procedures as we considered necessary in the circumstances. We believe that our examinations provide a reasonable basis for our opinion.

Because of inherent limitations in any system of internal control, errors or fraud may occur and not be detected. Also, projections of any evaluation of the system of internal control to future periods are subject to the risk that the system of internal control may become inadequate because of changes in conditions, or that the degree of compliance with the policies or procedures may deteriorate.

In our opinion, management's assertion that the system of internal control of Enron Corp. and its subsidiaries as of December 31, 1999, 1998 and 1997 was adequate to provide reasonable assurance as to the reliability of financial statements and the protection of assets from unauthorized acquisition, use or disposition is fairly stated, in all material respects, based upon current standards of control criteria.

Arthur Andersen LLP

Houston, Texas  
March 13, 2000

To the Shareholders and Board of Directors of Enron Corp.:

We have audited the accompanying consolidated balance sheet of Enron Corp. (an Oregon corporation) and subsidiaries as of December 31, 1999 and 1998, and the related consolidated statements of income, comprehensive income, cash flows and changes in shareholders' equity for each of the three years in the period ended December 31, 1999. These financial statements are the responsibility of Enron Corp.'s management. Our responsibility is to express an opinion on these financial statements based on our audits.

We conducted our audits in accordance with auditing standards generally accepted in the United States. Those standards require that we plan and perform the audit to obtain reasonable assurance about whether the financial statements are free of material misstatement. An audit includes examining, on a test basis, evidence supporting the amounts and disclosures in the financial statements. An audit also includes assessing the accounting principles used and significant estimates made by management, as well as evaluating the overall financial statement presentation. We believe that our audits provide a reasonable basis for our opinion.

In our opinion, the financial statements referred to above present fairly, in all material respects, the financial position of Enron Corp. and subsidiaries as of December 31, 1999 and 1998, and the results of their operations, cash flows and changes in shareholders' equity for each of the three years in the period ended December 31, 1999, in conformity with accounting principles generally accepted in the United States.

As discussed in Note 18 to the consolidated financial statements, Enron Corp. and subsidiaries changed its method of accounting for costs of start-up activities and its method of accounting for certain contracts involved in energy trading and risk management activities in the first quarter of 1999.

Arthur Andersen LLP

Houston, Texas  
March 13, 2000

## Enron Corp. and Subsidiaries Consolidated Income Statement

(In millions, except per share amounts)	Year ended December 31,		
	1999	1998	1997
<b>Revenues</b>			
Natural gas and other products	\$19,536	\$13,276	\$13,211
Electricity	15,238	13,939	5,101
Transportation	588	627	652
Other	4,750	3,418	1,309
Total revenues	40,112	31,260	20,273
<b>Costs and Expenses</b>			
Cost of gas, electricity and other products	34,761	26,381	17,311
Operating expenses	2,996	2,352	1,406
Oil and gas exploration expenses	49	121	102
Depreciation, depletion and amortization	870	827	600
Taxes, other than income taxes	193	201	164
Impairment of long-lived assets	441	-	-
Contract restructuring charge	-	-	675
Total costs and expenses	39,310	29,882	20,258
<b>Operating Income</b>	802	1,378	15
<b>Other Income and Deductions</b>			
Equity in earnings of unconsolidated equity affiliates	309	97	216
Gains on sales of assets and investments	541	56	186
Interest income	162	88	70
Other income, net	181	(37)	78
<b>Income Before Interest, Minority Interests and Income Taxes</b>	1,995	1,582	565
Interest and related charges, net	656	550	401
Dividends on company-obligated preferred securities of subsidiaries	76	77	69
Minority interests	135	77	80
Income tax expense (benefit)	104	175	(90)
Net income before cumulative effect of accounting changes	1,024	703	105
Cumulative effect of accounting changes, net of tax	(131)	-	-
<b>Net Income</b>	893	703	105
Preferred stock dividends	66	17	17
<b>Earnings on Common Stock</b>	\$ 827	\$ 686	\$ 88
<b>Earnings Per Share of Common Stock</b>			
Basic			
Before cumulative effect of accounting changes	\$ 1.36	\$ 1.07	\$ 0.16
Cumulative effect of accounting changes	(0.19)	-	-
Basic earnings per share	\$ 1.17	\$ 1.07	\$ 0.16
Diluted			
Before cumulative effect of accounting changes	\$ 1.27	\$ 1.01	\$ 0.16
Cumulative effect of accounting changes	(0.17)	-	-
Diluted earnings per share	\$ 1.10	\$ 1.01	\$ 0.16
<b>Average Number of Common Shares Used in Computation</b>			
Basic	705	642	544
Diluted	769	695	555

## Enron Corp. and Subsidiaries Consolidated Statement of Comprehensive Income

(In millions)	Year ended December 31,		
	1999	1998	1997
<b>Net Income</b>	\$ 893	\$ 703	\$ 105
Other comprehensive income:			
Foreign currency translation adjustment and other	(579)	(14)	(21)
<b>Total Comprehensive Income</b>	\$ 314	\$ 689	\$ 84

The accompanying notes are an integral part of these consolidated financial statements.

## Enron Corp. and Subsidiaries Consolidated Balance Sheet

(In millions, except shares)	December 31,	
	1999	1998
<b>ASSETS</b>		
<b>Current Assets</b>		
Cash and cash equivalents	\$ 288	\$ 111
Trade receivables (net of allowance for doubtful accounts of \$40 and \$14, respectively)	3,030	2,060
Other receivables	518	833
Assets from price risk management activities	2,205	1,904
Inventories	598	514
Other	616	511
Total current assets	7,255	5,933
<b>Investments and Other Assets</b>		
Investments in and advances to unconsolidated equity affiliates	5,036	4,433
Assets from price risk management activities	2,929	1,941
Goodwill	2,799	1,949
Other	4,681	4,437
Total investments and other assets	15,445	12,760
<b>Property, Plant and Equipment, at cost</b>		
Natural gas transmission	6,948	6,936
Electric generation and distribution	3,552	2,061
Construction in progress	1,491	989
Oil and gas, successful efforts method	690	4,814
Other	1,231	992
	13,912	15,792
Less accumulated depreciation, depletion and amortization	3,231	5,135
Property, plant and equipment, net	10,681	10,657
<b>Total Assets</b>	<b>\$33,381</b>	<b>\$29,350</b>

The accompanying notes are an integral part of these consolidated financial statements.

	December 31,	
	1999	1998
<b>LIABILITIES AND SHAREHOLDERS' EQUITY</b>		
<b>Current Liabilities</b>		
Accounts payable	\$ 2,154	\$ 2,380
Liabilities from price risk management activities	1,836	2,511
Short-term debt	1,001	-
Other	1,768	1,216
Total current liabilities	<u>6,759</u>	<u>6,107</u>
<b>Long-Term Debt</b>	<u>7,151</u>	<u>7,357</u>
<b>Deferred Credits and Other Liabilities</b>		
Deferred income taxes	1,894	2,357
Liabilities from price risk management activities	2,990	1,421
Other	1,587	1,916
Total deferred credits and other liabilities	<u>6,471</u>	<u>5,694</u>
<b>Commitments and Contingencies (Notes 3, 13, 14 and 15)</b>		
<b>Minority Interests</b>	<u>2,430</u>	<u>2,143</u>
<b>Company-Obligated Preferred Securities of Subsidiaries</b>	<u>1,000</u>	<u>1,001</u>
<b>Shareholders' Equity</b>		
Second preferred stock, cumulative, no par value, 1,370,000 shares authorized, 1,296,184 shares and 1,319,848 shares of Cumulative Second Preferred Convertible Stock issued, respectively	130	132
Mandatorily Convertible Junior Preferred Stock, Series B, no par value, 250,000 shares issued	1,000	-
Common stock, no par value, 1,200,000,000 shares authorized, 716,865,081 shares and 671,094,552 shares issued, respectively	6,637	5,117
Retained earnings	2,698	2,226
Accumulated other comprehensive income	(741)	(162)
Common stock held in treasury, 1,337,714 shares and 9,333,322 shares, respectively	(49)	(195)
Restricted stock and other	(105)	(70)
Total shareholders' equity	<u>9,570</u>	<u>7,048</u>
<b>Total Liabilities and Shareholders' Equity</b>	<u>\$33,381</u>	<u>\$29,350</u>

## Enron Corp. and Subsidiaries Consolidated Statement of Cash Flows

(In millions)	Year ended December 31,		
	1999	1998	1997
<b>Cash Flows From Operating Activities</b>			
Reconciliation of net income to net cash provided by operating activities			
Net income	\$ 893	\$ 703	\$ 105
Cumulative effect of accounting changes	131	-	-
Depreciation, depletion and amortization	870	827	600
Oil and gas exploration expenses	49	121	102
Impairment of long-lived assets	441	-	-
Deferred income taxes	21	87	(174)
Gains on sales of assets and investments	(541)	(82)	(195)
Changes in components of working capital	(1,000)	(233)	(65)
Net assets from price risk management activities	(395)	350	201
Merchant assets and investments:			
Realized gains on sales	(756)	(628)	(136)
Proceeds from sales	2,217	1,434	339
Additions and unrealized gains	(827)	(721)	(308)
Other operating activities	125	(218)	(258)
<b>Net Cash Provided by Operating Activities</b>	<b>1,228</b>	<b>1,640</b>	<b>211</b>
<b>Cash Flows From Investing Activities</b>			
Capital expenditures	(2,363)	(1,905)	(1,392)
Equity investments	(722)	(1,659)	(700)
Proceeds from sales of investments and other assets	294	239	473
Acquisition of subsidiary stock	-	(180)	-
Business acquisitions, net of cash acquired (see Note 2)	(311)	(104)	(82)
Other investing activities	(405)	(356)	(445)
<b>Net Cash Used in Investing Activities</b>	<b>(3,507)</b>	<b>(3,965)</b>	<b>(2,146)</b>
<b>Cash Flows From Financing Activities</b>			
Issuance of long-term debt	1,776	1,903	1,817
Repayment of long-term debt	(1,837)	(870)	(607)
Net increase (decrease) in short-term borrowings	1,565	(158)	464
Issuance of company-obligated preferred securities of subsidiaries	-	8	372
Issuance of common stock	852	867	-
Issuance of subsidiary equity	568	828	555
Dividends paid	(467)	(414)	(354)
Net (acquisition) disposition of treasury stock	139	13	(422)
Other financing activities	(140)	89	24
<b>Net Cash Provided by Financing Activities</b>	<b>2,456</b>	<b>2,266</b>	<b>1,849</b>
<b>Increase (Decrease) in Cash and Cash Equivalents</b>	<b>177</b>	<b>(59)</b>	<b>(86)</b>
<b>Cash and Cash Equivalents, Beginning of Year</b>	<b>111</b>	<b>170</b>	<b>256</b>
<b>Cash and Cash Equivalents, End of Year</b>	<b>\$ 288</b>	<b>\$ 111</b>	<b>\$ 170</b>
<b>Changes in Components of Working Capital</b>			
Receivables	\$ (662)	\$(1,055)	\$ 351
Inventories	(133)	(372)	63
Payables	(246)	433	(366)
Other	41	761	(113)
<b>Total</b>	<b>\$(1,000)</b>	<b>\$ (233)</b>	<b>\$ (65)</b>

The accompanying notes are an integral part of these consolidated financial statements.

## Enron Corp. and Subsidiaries Consolidated Statement of Changes in Shareholders' Equity

(In millions, except per share amounts; shares in thousands)	1999		1998		1997	
	Shares	Amount	Shares	Amount	Shares	Amount
<b>Cumulative Second Preferred Convertible Stock</b>						
Balance, beginning of year	1,320	\$ 132	1,338	\$ 134	1,371	\$ 137
Exchange of common stock for convertible preferred stock	(24)	(2)	(18)	(2)	(33)	(3)
Balance, end of year	1,296	\$ 130	1,320	\$ 132	1,338	\$ 134
<b>Mandatorily Convertible Junior Preferred Stock, Series B</b>						
Balance, beginning of year	-	\$ -	-	\$ -	-	\$ -
Issuances	250	1,000	-	-	-	-
Balance, end of year	250	\$1,000	-	\$ -	-	\$ -
<b>Common Stock</b>						
Balance, beginning of year	671,094	\$5,117	636,594	\$4,224	511,890	\$ 26
Exchange of common stock for convertible preferred stock	465	(1)	-	(7)	764	-
Issuances related to benefit and dividend reinvestment plans	10,054	258	-	45	-	(3)
Sales of common stock	27,600	839	34,500	836	-	-
Issuances of common stock in business acquisitions (see Note 2)	7,652	250	-	-	123,940	2,281
Issuance of no par stock in reincorporation merger	-	-	-	-	-	1,881
Other	-	174	-	19	-	39
Balance, end of year	716,865	\$6,637	671,094	\$5,117	636,594	\$4,224
<b>Additional Paid-in Capital</b>						
Balance, beginning of year	-	\$ -	-	\$ -	-	\$1,870
Sales and issuances of common stock	-	-	-	-	-	10
Issuance of no par stock in reincorporation merger	-	-	-	-	-	(1,881)
Other	-	-	-	-	-	1
Balance, end of year	-	\$ -	-	\$ -	-	\$ -
<b>Retained Earnings</b>						
Balance, beginning of year	-	\$2,226	-	\$1,852	-	\$2,007
Net income	-	893	-	703	-	105
Cash dividends	-	-	-	-	-	-
Common stock (\$0.5000, \$0.4812 and \$0.4562 per share in 1999, 1998 and 1997, respectively)	-	(355)	-	(312)	-	(243)
Cumulative Second Preferred Convertible Stock (\$13.652, \$13.1402 and \$12.4584 per share in 1999, 1998 and 1997, respectively)	-	(17)	-	(17)	-	(17)
Series A and B Preferred Stock	-	(49)	-	-	-	-
Balance, end of year	-	\$2,698	-	\$2,226	-	\$1,852
<b>Accumulated Other Comprehensive Income</b>						
Balance, beginning of year	-	\$ (162)	-	\$ (148)	-	\$ (127)
Translation adjustments and other	-	(579)	-	(14)	-	(21)
Balance, end of year	-	\$ (741)	-	\$ (162)	-	\$ (148)
<b>Treasury Stock</b>						
Balance, beginning of year	(9,334)	\$ (195)	(14,102)	\$ (269)	(1,642)	\$ (30)
Shares acquired	(1,845)	(71)	(2,236)	(61)	(19,580)	(374)
Exchange of common stock for convertible preferred stock	181	4	486	9	140	3
Issuances related to benefit and dividend reinvestment plans	9,660	213	6,426	124	5,676	106
Issuances of treasury stock in business acquisitions (see Note 2)	-	-	92	2	1,304	26
Balance, end of year	(1,338)	\$ (49)	(9,334)	\$ (195)	(14,102)	\$ (269)
<b>Restricted Stock and Other</b>						
Balance, beginning of year	-	\$ (70)	-	\$ (175)	-	\$ (160)
Issuances related to benefit and dividend reinvestment plans	-	(35)	-	105	-	(15)
Balance, end of year	-	\$ (105)	-	\$ (70)	-	\$ (175)
<b>Total Shareholders' Equity</b>	<b>9,570</b>	<b>\$9,570</b>	<b>7,048</b>	<b>\$7,048</b>	<b>5,618</b>	<b>\$5,618</b>

The accompanying notes are an integral part of these consolidated financial statements.

# Enron Corp. and Subsidiaries Notes to the Consolidated Financial Statements

## 1 SUMMARY OF SIGNIFICANT ACCOUNTING POLICIES

### Consolidation Policy and Use of Estimates

The accounting and financial reporting policies of Enron Corp. and its subsidiaries conform to generally accepted accounting principles and prevailing industry practices. The consolidated financial statements include the accounts of all subsidiaries controlled by Enron Corp. after the elimination of significant intercompany accounts and transactions, unless control is temporary.

The preparation of financial statements in conformity with generally accepted accounting principles requires management to make estimates and assumptions that affect the reported amounts of assets and liabilities and disclosure of contingent assets and liabilities at the date of the financial statements and the reported amounts of revenues and expenses during the reporting period. Actual results could differ from those estimates.

"Enron" is used from time to time herein as a collective reference to Enron Corp. and its subsidiaries and affiliates. The businesses of Enron are conducted by Enron Corp.'s subsidiaries and affiliates whose operations are managed by their respective officers.

### Cash Equivalents

Enron records as cash equivalents all highly liquid short-term investments with original maturities of three months or less.

### Inventories

Inventories consist primarily of commodities, priced at market.

### Depreciation, Depletion and Amortization

The provision for depreciation and amortization with respect to operations other than oil and gas producing activities is computed using the straight-line or regulatorily mandated method, based on estimated economic lives. Composite depreciation rates are applied to functional groups of property having similar economic characteristics. The cost of utility property units retired, other than land, is charged to accumulated depreciation.

Provisions for depreciation, depletion and amortization of proved oil and gas properties are calculated using the units-of-production method.

### Income Taxes

Enron accounts for income taxes using an asset and liability approach under which deferred tax assets and liabilities are recognized based on anticipated future tax consequences attributable to differences between financial statement carrying amounts of assets and liabilities and their respective tax bases (see Note 5).

### Earnings Per Share

Basic earnings per share is computed based upon the weighted-average number of common shares outstanding during the periods. Diluted earnings per share is computed based upon the weighted-average number of common shares outstanding plus the assumed issuance of common shares for all potentially dilutive securities. All share and per share amounts have been adjusted to reflect the August 13, 1999 two-for-one stock split. See Note 11 for a reconciliation of the basic and diluted earnings per share computations.

### Accounting for Price Risk Management

Enron engages in price risk management activities for both trading and non-trading purposes. Instruments utilized in connection with trading activities are accounted for using the mark-to-market method. Under the mark-to-market method of accounting, forwards, swaps, options, energy transportation contracts utilized for trading activities and other instruments with third parties are reflected at fair value and are shown as "Assets and Liabilities from Price Risk Management Activities" in the Consolidated Balance Sheet. These activities also include the risk management component embedded in energy outsourcing contracts. Unrealized gains and losses from newly originated contracts, contract restructurings and the impact of price movements are recognized as "Other Revenues." Changes in the assets and liabilities from price risk management activities result primarily from changes in the valuation of the portfolio of contracts, newly originated transactions and the timing of settlement relative to the receipt of cash for certain contracts. The market prices used to value these transactions reflect management's best estimate considering various factors including closing exchange and over-the-counter quotations, time value and volatility factors underlying the commitments. The values are adjusted to reflect the potential impact of liquidating Enron's position in an orderly manner over a reasonable period of time under present market conditions.

Financial instruments are also utilized for non-trading purposes to hedge the impact of market fluctuations on assets, liabilities, production and other contractual commitments. Hedge accounting is utilized in non-trading activities when there is a high degree of correlation between price movements in the derivative and the item designated as being hedged. In instances where the anticipated correlation of price movements does not occur, hedge accounting is terminated and future changes in the value of the financial instruments are recognized as gains or losses. If the hedged item is sold, the value of the financial instrument is recognized in income. Gains and losses on financial instruments used for hedging purposes are recognized in the Consolidated Income Statement in the same manner as the hedged item.

The cash flow impact of financial instruments is reflected as cash flows from operating activities in the Consolidated Statement of Cash Flows. See Note 3 for further discussion of Enron's price risk management activities.

### Accounting for Oil and Gas Producing Activities

Enron accounts for oil and gas exploration and production activities under the successful efforts method of accounting. All development wells and related production equipment and lease acquisition costs are capitalized when incurred. Unproved properties are assessed regularly and any impairment in value is recognized. Lease rentals and exploration costs, other than the costs of drilling exploratory wells, are expensed as incurred. Unsuccessful exploratory wells are expensed when determined to be non-productive.

Exploration costs and dry hole costs are included in the Consolidated Statement of Cash Flows as investing activities.



### Accounting for Development Activity

Development costs related to projects, including costs of feasibility studies, bid preparation, permitting, licensing and contract negotiation, are expensed as incurred until the project is estimated to be probable. At that time, such costs are capitalized or expensed as incurred, based on the nature of the costs incurred. Capitalized development costs may be recovered through reimbursements from joint venture partners or other third parties, or classified as part of the investment and recovered through the cash flows from that project. Accumulated capitalized project development costs are otherwise expensed in the period that management determines it is probable that the costs will not be recovered.

### Environmental Expenditures

Expenditures that relate to an existing condition caused by past operations, and do not contribute to current or future revenue generation, are expensed. Environmental expenditures relating to current or future revenues are expensed or capitalized as appropriate based on the nature of the costs incurred. Liabilities are recorded when environmental assessments and/or clean-ups are probable and the costs can be reasonably estimated.

### Computer Software

Enron's accounting policy for the costs of computer software (all of which is for internal use only) is to capitalize direct costs of materials and services consumed in developing or obtaining software, including payroll and payroll-related costs for employees who are directly associated with and who devote time to the software project. Costs may begin to be capitalized once the application development stage has begun. All other costs are expensed as incurred. Enron amortizes the costs on a straight-line basis over the useful life of the software. Impairment is evaluated based on changes in the expected usefulness of the software. At December 31, 1999 and 1998, Enron has capitalized \$240 million and \$189 million, respectively, of software costs covering numerous systems, including trading and settlement, billing and payroll systems and upgrades.

### Investments in Unconsolidated Affiliates

Investments in unconsolidated affiliates are accounted for by the equity method, except for certain investments resulting from Enron's merchant investment activities which are included at market value in "Other Investments" in the Consolidated Balance Sheet. See Notes 4 and 9. Where acquired assets are accounted for under the equity method based on temporary control, earnings or losses are recognized only for the portion of the investment to be retained.

### Foreign Currency Translation

For international subsidiaries, asset and liability accounts are translated at year-end rates of exchange and revenue and expenses are translated at average exchange rates prevailing during the year. For subsidiaries whose functional currency is deemed to be other than the U.S. dollar, translation adjustments are included as a separate component of other comprehensive income and shareholders' equity. Currency transaction gains and losses are recorded in income.

### Reclassifications

Certain reclassifications have been made to the consolidated financial statements for prior years to conform with the current presentation.

## 2 BUSINESS ACQUISITIONS AND DISPOSITIONS

On August 16, 1999, Enron exchanged approximately 62.3 million shares (approximately 75%) of the Enron Oil & Gas Company (EOG) common stock it held for all of the stock of EOGI-India, Inc., a subsidiary of EOG. EOGI-India, Inc. indirectly owns oil and gas operations in India and China and \$600 million of cash. Also in August 1999, Enron received net proceeds of approximately \$190 million for the sale of 8.5 million shares of EOG common stock in a public offering and issued approximately \$255 million of public debt that is exchangeable in July 2002 into approximately 11.5 million shares of EOG common stock. As a result of the share exchange and share sale, Enron recorded a pre-tax gain of \$454 million (\$345 million after tax, or \$0.45 per diluted share) in 1999. Enron retained 11.5 million shares of EOG stock (now EOG Resources, Inc.) which will be exchanged at the maturity of the debt. As of August 16, 1999, EOG is no longer included in Enron's consolidated financial statements. As a result, net property, plant and equipment decreased by approximately \$2,400 million, short- and long-term debt decreased by approximately \$1,800 million and minority interests decreased by approximately \$600 million. EOGI-India, Inc. is included in the consolidated financial statements within the Wholesale Energy Operations and Services segment following the exchange and sale.

In August 1998, Enron, through a wholly-owned subsidiary, completed the acquisition of a controlling interest in Elektro Eletricidade e Serviços S.A. (Elektro), an electricity distributor in Brazil, for approximately \$1.3 billion. Enron's interest in Elektro is held by Jacaré Electrical Distribution Trust (Jacaré) and was initially accounted for using the equity method based on temporary control. In December 1998, Enron financially closed the Elektro financial restructuring, reducing its interest in Jacaré to 51%. Following the decision by Enron to acquire additional interests in Elektro, Enron consolidated Jacaré effective January 1, 1999. Jacaré's balance sheet at that date consisted of net assets of approximately \$1,340 million, including goodwill of approximately \$990 million, net property, plant and equipment of approximately \$1,100 million and debt of approximately \$900 million. As a result of the consolidation, as of January 1, 1999, Enron's investment in unconsolidated affiliates decreased by approximately \$450 million and minority interests increased by approximately \$890 million. During 1999, the exchange rate for the Brazilian real to the U.S. dollar declined, resulting in a non-cash foreign currency translation adjustment which reduced Enron's Brazilian assets (primarily Elektro) and shareholders' equity by approximately \$600 million.

In November 1997, Enron acquired the minority interest in Enron Global Power & Pipelines L.L.C. (EPP) in a stock-for-stock transaction. Enron issued approximately 23 million common shares in exchange for the EPP shares held by the minority shareholders.

Effective July 1, 1997, Enron merged with Portland General Corporation (PGC) in a stock-for-stock transaction. Enron issued approximately 101 million common shares to shareholders of PGC and assumed PGC's outstanding debt of approximately \$1.1 billion.

Additionally, during 1999, 1998 and 1997, Enron acquired generation, natural gas distribution, renewable energy, telecommunications and energy management businesses for cash, Enron and subsidiary stock and notes.

Enron has accounted for these acquisitions using the purchase method of accounting as of the effective date of each transaction. Accordingly, the purchase price of each transaction has been allocated based upon the estimated fair value of the assets and liabilities acquired as of the acquisition date, with the excess reflected as goodwill in the Consolidated Balance Sheet. This goodwill is being amortized on a straight-line basis over 5 to 40 years.

Assets acquired, liabilities assumed and consideration paid as a result of businesses acquired were as follows:

(In millions)	1999	1998 <sup>(a)</sup>	1997
Fair value of assets acquired, other than cash	\$376	\$ 269	\$ 3,829
Goodwill	(71)	94	1,847
Fair value of liabilities assumed	6	(259)	(3,235)
Common stock of Enron and subsidiary issued	-	-	(2,359)
Net cash paid	\$311	\$ 104	\$ 82

(a) Excludes amounts related to the 1998 acquisition of Elektro prior to the consolidation of Jacaré.

If the PGC and EPP acquisitions had occurred at the beginning of 1997, Enron's 1997 consolidated revenues would have been \$20,950 million, income before interest, minority interests and income taxes would have been \$716 million, net income would have been \$181 million and earnings per share would have been \$0.27 (basic) and \$0.26 (diluted). These unaudited pro forma results are for illustrative purposes only and are not necessarily indicative of the operating results that would have occurred had the business acquisitions been consummated at that date, nor are they necessarily indicative of future operating results.

On November 8, 1999, Enron announced that it had entered into an agreement to sell Enron's wholly-owned electric utility subsidiary, Portland General Electric Company (PGE), to Sierra Pacific Resources for \$2.1 billion, comprised of \$2.02 billion in cash and the assumption of Enron's approximately \$80 million merger payment obligation. Sierra Pacific Resources will also assume approximately \$1 billion in PGE debt and preferred stock. The proposed transaction, which is subject to customary regulatory approvals, is expected to close in late 2000. Enron's carrying amount of PGE is approximately \$1.4 billion. Income before interest, minority interest and income taxes for PGE was \$298 million and \$284 million for 1999 and 1998, respectively, and \$114 million for the six months ended December 31, 1997.

### 3 PRICE RISK MANAGEMENT ACTIVITIES AND FINANCIAL INSTRUMENTS

#### Trading Activities

Enron, through its Wholesale Energy Operations and Services (Enron Wholesale) and Retail Energy Services (Energy Services) segments, offers price risk management services to wholesale, commercial and industrial customers through a variety of financial and other instruments including forward contracts involving physical delivery of an energy commodity, swap agreements, which require payments to (or receipt of payments from) counterparties based on the differential between a fixed and variable price for the commodity, options and other contractual arrangements. Interest rate risks and foreign currency risks associated with the fair value of the commodity portfolio are managed using a variety of financial instruments, including financial futures.

**Notional Amounts and Terms.** The notional amounts and terms of these instruments at December 31, 1999 are shown below (volumes in trillions of British thermal units equivalent (TBtue), dollars in millions):

	Fixed Price Payor	Fixed Price Receiver	Maximum Terms in Years
Commodities			
Natural gas	6,642	5,921	24
Crude oil and liquids	1,342	749	7
Electricity	1,853	1,606	25
Other	352	541	10
Financial products			
Interest rate <sup>(a)</sup>	\$2,151	\$4,288	29
Foreign currency	619	88	15
Equity investments	2,195	882	14

(a) The interest rate fixed price receiver includes the net notional dollar value of the interest rate sensitive component of the combined commodity portfolio. The remaining interest rate fixed price receiver and the entire interest rate fixed price payor represent the notional contract amount of a portfolio of various financial instruments used to hedge the net present value of the commodity portfolio. For a given unit of price protection, different financial instruments require different notional amounts.

Enron Wholesale and Energy Services include sales and purchase commitments associated with commodity contracts based on market prices totaling 9,013 TBtue, with terms extending up to 21 years.

Notional amounts reflect the volume of transactions but do not represent the amounts exchanged by the parties to the financial instruments. Accordingly, notional amounts do not accurately measure Enron's exposure to market or credit risks. The maximum terms in years detailed above are not indicative of likely future cash flows as these positions may be offset in the markets at any time in response to the company's price risk management needs to the extent available in the market.

The volumetric weighted average maturity of Enron's fixed price portfolio as of December 31, 1999 was approximately 2.0 years.

**Fair Value.** The fair value as of December 31, 1999 and the average fair value of instruments related to price risk management activities, including energy related commodities together with the related foreign currency and interest rate instruments, other commodities and equities held during the year are set forth below:

(In millions)	Fair Value as of 12/31/99		Average Fair Value for the Year Ended 12/31/99 <sup>(a)</sup>	
	Assets	Liabilities	Assets	Liabilities
Natural gas	\$3,267	\$2,335	\$3,080	\$2,506
Crude oil and liquids	649	1,832	806	1,486
Electricity	906	380	726	352
Other commodities	163	32	219	129
Equity	486	247	165	149
Total	\$5,471	\$4,826	\$4,996	\$4,622

(a) Computed using the ending balance at each month-end.

The income before interest, taxes and certain unallocated expenses arising from price risk management activities for 1999 was \$765 million.

**Credit Risk.** In conjunction with the valuation of its financial instruments, Enron provides reserves for risks associated with such activity, including credit risk. Credit risk relates to the risk of loss that Enron would incur as a result of nonperformance by counterparties pursuant to the terms of their contractual obligations. Enron maintains credit policies with regard to its counterparties that management believes significantly minimize overall credit risk. These policies include an evaluation of potential counterparties' financial condition (including credit rating), collateral requirements under certain circumstances and the use of standardized agreements which allow for the netting of positive and negative exposures associated with a single counterparty. Enron also

minimizes this credit exposure using monetization of its contract portfolio or third-party insurance contracts. The counterparties associated with assets from price risk management activities as of December 31, 1999 and 1998 are summarized as follows:

(In millions)	1999		1998	
	Investment Grade <sup>(a)</sup>	Total	Investment Grade <sup>(a)</sup>	Total
Gas and electric utilities	\$1,461	\$1,510	\$1,181	\$1,251
Energy marketers	544	768	684	795
Financial institutions	1,016	1,273	505	505
Independent power producers	471	641	416	613
Oil and gas producers	379	688	365	549
Industrials	336	524	229	341
Other	59	67	101	116
Total	<u>\$4,266</u>	<u>5,471</u>	<u>\$3,481</u>	4,170
Credit and other reserves		<u>(337)</u>		<u>(325)</u>
Assets from price risk management activities <sup>(b)</sup>		<u>\$5,134</u>		<u>\$3,845</u>

(a) "Investment Grade" is primarily determined using publicly available credit ratings along with consideration of collateral, which encompass standby letters of credit, parent company guarantees and property interests, including oil and gas reserves. Included in "Investment Grade" are counterparties with a minimum Standard & Poor's or Moody's rating of BBB- or Baa3, respectively.

(b) Two customers' exposures at December 31, 1999 and 1998 comprise greater than 5% of Assets From Price Risk Management Activities and are included above as Investment Grade.

This concentration of counterparties may impact Enron's overall exposure to credit risk, either positively or negatively, in that the counterparties may be similarly affected by changes in economic, regulatory or other conditions. Based on Enron's policies, its exposures and its credit and other reserves, Enron does not anticipate a materially adverse effect on financial position or results of operations as a result of counterparty nonperformance.

#### Non-Trading Activities

Enron's other businesses also enter into swaps and other contracts primarily for the purpose of hedging the impact of market fluctuations on assets, liabilities, production or other contractual commitments.

**Energy Commodity Price Swaps.** At December 31, 1999, Enron was a party to energy commodity price swaps covering 15.4 TBtu, 3.5 TBtu and 15.0 TBtu of natural gas for the years 2000, 2001 and 2002, respectively, and 2.2 million barrels of crude oil for the year 2000.

**Interest Rate Swaps.** At December 31, 1999, Enron had entered into interest rate swap agreements with an aggregate notional principal amount of \$2.2 billion to manage interest rate exposure. These swap agreements are scheduled to terminate \$1.4 billion in 2000 and \$0.8 billion in the period 2001 through 2008.

**Equity Contracts.** At December 31, 1999, Enron had entered into Enron common stock swaps, with an aggregate notional amount of \$60 million, to hedge certain incentive-based compensation plans. Such contracts will expire in 2000.

**Credit Risk.** While notional amounts are used to express the volume of various financial instruments, the amounts potentially subject to credit risk, in the event of nonperformance by the third parties, are substantially smaller. Counterparties to forwards, futures and other contracts are equivalent to investment grade financial institutions. Accordingly, Enron does not anticipate any material impact to its financial position or results of operations as a result of nonperformance by the third-parties on financial instruments related to non-trading activities.

Enron has concentrations of customers in the electric and gas utility and oil and gas exploration and production industries. These concentrations of customers may impact Enron's overall exposure to credit risk, either positively or negatively, in that the customers may be similarly affected by changes in economic or other conditions. However, Enron's management believes that its portfolio of receivables is well diversified and that such diversification minimizes any potential credit risk. Receivables are generally not collateralized.

#### Financial Instruments

The carrying amounts and estimated fair values of Enron's financial instruments, excluding trading activities which are marked to market, at December 31, 1999 and 1998 were as follows:

(In millions)	1999		1998	
	Carrying Amount	Estimated Fair Value	Carrying Amount	Estimated Fair Value
Short- and long-term debt (Note 7)	\$8,152	\$8,108	\$7,357	\$7,624
Company-obligated preferred securities of subsidiaries (Note 10)	1,000	937	1,001	1,019
Energy commodity price swaps	-	(3)	-	(5)
Interest rate swaps	-	(55)	-	12
Equity contracts	4	4	-	-

Enron uses the following methods and assumptions in estimating fair values: (a) short- and long-term debt – the carrying amount of variable-rate debt approximates fair value, the fair value of marketable debt is based on quoted market prices and the fair value of other debt is based on the discounted present value of cash flows using Enron's current borrowing rates; (b) company-obligated preferred securities of subsidiaries – the fair value is based on quoted market prices, where available, or based on the discounted present value of cash flows using Enron's current borrowing rates if not publicly traded; and (c) energy commodity price swaps, interest rate swaps and equity contracts – estimated fair values have been determined using available market data and valuation methodologies. Judgment is necessarily required in interpreting market data and the use of different market assumptions or estimation methodologies may affect the estimated fair value amounts.

The fair market value of cash and cash equivalents, trade and other receivables, accounts payable and investments accounted for at fair value are not materially different from their carrying amounts.

Guarantees of liabilities of unconsolidated entities and residual value guarantees have no carrying value and fair values which are not readily determinable (see Note 15).

#### 4 MERCHANT ACTIVITIES

An analysis of the composition of Enron's wholesale merchant investments and energy assets at December 31, 1999 and 1998 is as follows:

(In millions)	December 31,	
	1999	1998
Merchant investments		
Held directly by Enron <sup>(a)</sup>		
Energy	\$ 516	\$ 279
Energy-intensive industries	218	331
Natural gas transportation	-	132
Other	352	334
	<u>1,086</u>	<u>1,076</u>
Held through unconsolidated affiliates <sup>(b)</sup>		
Energy	401	610
Power generation	98	-
Oil services	25	123
Other	88	50
	<u>612</u>	<u>783</u>
	<u>1,698</u>	<u>1,859</u>
Merchant assets <sup>(c)</sup>		
Independent power plants	152	148
Natural gas transportation	35	38
	<u>187</u>	<u>186</u>
<b>Total</b>	<b>\$1,885</b>	<b>\$2,045</b>

(a) Investments are recorded at fair value in "Other Assets" with fair value adjustments reflected in "Other Revenues."

(b) Investments held through unconsolidated equity affiliates and recorded in "Investment in and Advances to Unconsolidated Equity Affiliates" with earnings reflected in "Equity in Earnings of Unconsolidated Equity Affiliates." Amounts represent Enron's interest.

(c) Amounts represent Enron's investment in unconsolidated equity affiliates with earnings reflected in "Equity in Earnings of Unconsolidated Equity Affiliates."

Through the Enron Wholesale segment, Enron provides capital primarily to energy and communications-related businesses seeking debt or equity financing. The merchant investments made by Enron and carried at fair value include public and private equity, debt, production payments, government securities with maturities of more than 90 days and interests in limited partnerships. The valuation methodologies utilize market values of publicly-traded securities, independent appraisals and cash flow analyses.

Also included in Enron's wholesale business are investments in merchant assets such as power plants and natural gas pipelines, primarily held through equity method investments. Some of these assets were developed, constructed and operated by Enron. The merchant assets are not expected to be long-term, integrated components of Enron's energy networks.

From time to time, Enron sells interests in these merchant assets and investments. Some of these sales are completed in securitizations, in which Enron retains certain interests through swaps associated with the underlying assets. Such swaps are adjusted to fair value using quoted market prices, if available, or estimated fair value based on management's best estimate of the present value of future cash flow. These swaps are included in Price Risk Management activities. See Note 3. For the years ended December 31, 1999, 1998 and 1997, respectively, pre-tax gains from sales of merchant assets and investments totaling \$756 million, \$628 million and \$136 million are included in "Other Revenues," and proceeds were \$2,217 million, \$1,434 million and \$339 million.

#### 5 INCOME TAXES

The components of income before income taxes are as follows:

(In millions)	1999	1998	1997
United States	\$ 357	\$197	\$ 96
Foreign	771	681	(81)
	<u>\$1,128</u>	<u>\$878</u>	<u>\$ 15</u>

Total income tax expense (benefit) is summarized as follows:

(In millions)	1999	1998	1997
Payable currently			
Federal	\$ 29	\$ 30	\$ 29
State	6	8	9
Foreign	48	50	46
	<u>83</u>	<u>88</u>	<u>84</u>
Payment deferred			
Federal	(159)	(14)	(39)
State	23	11	(42)
Foreign	157	90	(93)
	<u>21</u>	<u>87</u>	<u>(174)</u>
<b>Total income tax expense (benefit)</b>	<b>\$ 104</b>	<b>\$175</b>	<b>\$ (90)</b>

The differences between taxes computed at the U.S. federal statutory tax rate and Enron's effective income tax rate are as follows:

(In millions, except percentages)	1999	1998	1997
Statutory federal income tax provision	35.0%	35.0%	35.0%
Net state income taxes	1.8	1.7	(140.0)
Tight gas sands tax credit	(0.5)	(1.4)	(80.0)
Foreign tax rate differential	(7.0)	0.8	13.3
Equity earnings	(10.1)	(4.3)	(253.3)
Minority interests	0.8	0.8	186.7
Basis and stock sale differences	(10.8)	(14.2)	(526.7)
Cash value in life insurance	(0.9)	(1.1)	(46.7)
Goodwill amortization	1.6	2.0	60.0
Audit settlement related to Monthly Income Preferred Shares	(1.8)	-	-
Other	1.1	0.7	153.4
	<u>9.2%</u>	<u>20.0%</u>	<u>(598.3)%</u>

The principal components of Enron's net deferred income tax liability are as follows:

(In millions)	December 31,	
	1999	1998
Deferred income tax assets		
Alternative minimum tax credit carryforward	\$ 220	\$ 238
Net operating loss carryforward	1,302	605
Other	188	111
	<u>1,710</u>	<u>954</u>
Deferred income tax liabilities		
Depreciation, depletion and amortization	1,807	1,940
Price risk management activities	1,133	645
Other	782	700
	<u>3,722</u>	<u>3,285</u>
<b>Net deferred income tax liabilities<sup>(a)</sup></b>	<b>\$2,012</b>	<b>\$2,331</b>

(a) Includes \$118 million and \$(26) million in other current liabilities for 1999 and 1998, respectively.

Enron has an alternative minimum tax (AMT) credit carryforward of approximately \$220 million which can be used to offset regular income taxes payable in future years. The AMT credit has an indefinite carryforward period.

Enron has a federal consolidated net operating loss carryforward for tax purposes of approximately \$2.9 billion, which will begin to expire in 2011. Enron also has a net operating loss carryforward applicable to non-U.S. subsidiaries of approximately \$874 million, of which \$673 million can be carried forward indefinitely. The remaining \$201 million of net operating loss carryforward will begin to expire in 2002 but is projected to be utilized before its expiration period. The benefits of the domestic and foreign net operating losses have been recognized as deferred tax assets.

U.S. and foreign income taxes have been provided for earnings of foreign subsidiary companies that are expected to be remitted to the U.S. Foreign subsidiaries' cumulative undistributed earnings of approximately \$1.2 billion are considered to be indefinitely reinvested outside the U.S. and, accordingly, no U.S. income taxes have been provided thereon. In the event of a distribution of those earnings in the form of dividends, Enron may be subject to both foreign withholding taxes and U.S. income taxes net of allowable foreign tax credits.

## 6 SUPPLEMENTAL CASH FLOW INFORMATION

Cash paid for income taxes and interest expense, including fees incurred on sales of accounts receivable, is as follows:

(In millions)	1999	1998	1997
Income taxes (net of refunds)	\$ 51	\$ 73	\$ 68
Interest (net of amounts capitalized)	678	585	420

### Non-Cash Activity

In December 1999, Enron and a third-party investor each contributed assets valued at approximately \$500 million for interests in an Enron-controlled limited partnership. See Note 8.

In June 1999, Enron entered into a series of transactions with a third party, LJM Cayman, L.P., which resulted in an exchange of assets. See Note 16.

During 1999, Enron received the rights to specific third-party fiber optic cable in exchange for the rights on specific fiber optic cable held for sale by Enron. These exchanges resulted in non-cash increases to property, plant and equipment of \$111 million.

During 1999, Enron issued approximately 7.6 million shares of common stock in connection with the acquisition, by an unconsolidated equity affiliate, of interests in three power plants in New Jersey. During 1997, Enron issued common stock in connection with other business acquisitions. See Note 2.

In December 1998, Enron extinguished its 6.25% Exchangeable Notes with 10.5 million shares of EOG common stock.

Additionally, Enron's investment in Jacaré has been consolidated effective January 1, 1999 (see Note 2) and Whitewing Associates, L.P. (Whitewing) and EOG are no longer consolidated by Enron (see Notes 9 and 2).

## 7 CREDIT FACILITIES AND DEBT

Enron has credit facilities with domestic and foreign banks which provide for an aggregate of \$1.0 billion in long-term committed credit and \$1.8 billion in short-term committed credit. Expiration dates of the committed facilities range from April 2000 to November 2001. Interest rates on borrowings are based upon the London Interbank Offered Rate, certificate of deposit rates or other short-term interest rates. Certain credit

facilities contain covenants which must be met to borrow funds. Such debt covenants are not anticipated to materially restrict Enron's ability to borrow funds under such facilities. Compensating balances are not required, but Enron is required to pay a commitment or facility fee. At December 31, 1999, no amounts were outstanding under these facilities.

Enron has also entered into agreements which provide for uncommitted lines of credit totaling \$225 million at December 31, 1999. The uncommitted lines have no stated expiration dates. Neither compensating balances nor commitment fees are required, as borrowings under the uncommitted credit lines are available subject to agreement by the participating banks. At December 31, 1999, \$125 million was outstanding under the uncommitted lines.

In addition to borrowing from banks on a short-term basis, Enron and certain of its subsidiaries sell commercial paper to provide financing for various corporate purposes. As of December 31, 1999 and 1998, short-term borrowings of \$330 million and \$680 million, respectively, have been reclassified as long-term debt based upon the availability of committed credit facilities with expiration dates exceeding one year and management's intent to maintain such amounts in excess of one year subject to overall reductions in debt levels. Similarly, at December 31, 1999 and 1998, \$670 million and \$541 million, respectively, of long-term debt due within one year remained classified as long-term. Weighted average interest rates on short-term debt outstanding at December 31, 1999 and 1998 were 6.4% and 5.5%, respectively.

Detailed information on long-term debt is as follows:

(In millions)	December 31,	
	1999	1998
<b>Enron Corp.</b>		
Senior debentures		
6.75% to 8.25% due 2005 to 2012	\$ 318	\$ 350
Notes payable		
7.00% exchangeable notes due 2002	239	-
6.45% to 9.88% due 2001 to 2028	4,209	3,342
Floating rate notes due 1999 to 2004	329	400
Other	34	38
<b>Northern Natural Gas Company</b>		
Notes payable		
6.75% to 8.00% due 2005 to 2011	500	500
<b>Transwestern Pipeline Company</b>		
Notes payable		
7.55% to 9.20% due 2000 to 2004	142	147
<b>Portland General</b>		
First mortgage bonds		
6.47% to 9.46% due 1999 to 2023	398	502
Pollution control bonds		
Various rates due 2010 to 2033	200	200
Other	150	160
<b>Enron Oil &amp; Gas Company</b>		
Notes payable various rates due 1999 to 2028	-	780
Other	356	302
Amount reclassified from short-term debt	330	680
Unamortized debt discount and premium	(54)	(44)
<b>Total long-term debt</b>	<b>\$7,151</b>	<b>\$7,357</b>

The indenture securing Portland General's First Mortgage Bonds constitutes a direct first mortgage lien on substantially all electric utility property and franchises, other than expressly excepted property.

The aggregate annual maturities of long-term debt outstanding at December 31, 1999 were \$670 million, \$569 million, \$432 million, \$494 million and \$493 million for 2000 through 2004, respectively.

## 8 MINORITY INTERESTS

Enron's minority interests at December 31, 1999 and 1998 include the following:

(In millions)	1999	1998
Majority-owned limited partnerships	\$1,773	\$ 750
Jacaré Electrical Distribution Trust (see Note 2)	475	-
Enron Oil & Gas Company (see Note 2)	-	596
Whitewing Associates, L.P. (see Note 9)	-	500
Other	182	297
	<u>\$2,430</u>	<u>\$2,143</u>

Enron has formed separate limited partnerships with third-party investors for various purposes. These entities are included in Enron's consolidated financial statements, with the third-party investors' interests reflected in "Minority Interests" in the Consolidated Balance Sheet.

During 1999, third-party investors contributed cash and merchant investments totaling \$1.0 billion to Enron-sponsored entities to invest in highly liquid investment grade securities (including Enron notes) and short-term receivables. The merchant investments, totaling \$500 million, were sold prior to December 31, 1999.

In 1998, Enron formed a wholly-owned limited partnership for the purpose of holding \$1.6 billion of assets contributed by Enron. That partnership contributed \$850 million of assets to a second newly-formed limited partnership in exchange for a 53% interest; a third-party investor contributed \$750 million in exchange for a 47% interest. The assets held by the wholly-owned limited partnership represent collateral for a \$750 million note receivable held by the second limited partnership. In 1999, the wholly-owned and second limited partnerships sold assets valued at approximately \$460 million and invested the proceeds in Enron notes.

Absent certain defaults or other specified events, Enron has the option to acquire the minority holders' interests in these partnerships. If Enron does not acquire the minority holders' interests before December 2004 through May 2009, or earlier upon certain specified events, the entities will liquidate their assets and dissolve.

## 9 UNCONSOLIDATED EQUITY AFFILIATES

Enron's investment in and advances to unconsolidated affiliates which are accounted for by the equity method is as follows:

(In millions)	Net Ownership Interest	December 31,	
		1999	1998
Azurix Corp.	34%	\$ 762	\$ 918
Citrus Corp.	50%	480	455
Companhia Distribuidora de Gas do Rio de Janeiro, S.A.	25%	118	192
Dabhol Power Company <sup>(a)</sup>	60%	466	285
Enron Teesside Operations Limited	50%	129	118
Jacaré Electrical Distribution Trust <sup>(a)</sup> (see Note 2)	51%	-	447
Joint Energy Development Investments L.P. (JEDI) <sup>(b)</sup>	50%	211	356
Joint Energy Development Investments II L.P. (JEDI II) <sup>(b)</sup>	50%	162	54
SK - Enron Co. Ltd.	50%	269	-
Transportadora de Gas del Sur S.A.	35%	452	463
Whitewing Associates, L.P.	50%	662	-
Other		<u>1,325</u>	<u>1,145</u>
		<u>\$5,036<sup>(c)</sup></u>	<u>\$4,433</u>

(a) Accounted for under the equity method based on temporary control.

(b) JEDI and JEDI II account for their investments at fair value.

(c) At December 31, 1999 and 1998, the unamortized excess of Enron's investment in unconsolidated affiliates was \$179 million and \$203 million, respectively, which is being amortized over the expected lives of the investments.

Enron's equity in earnings (losses) of unconsolidated equity affiliates is as follows:

(In millions)	1999	1998	1997
Citrus Corp.	\$ 25	\$ 23	\$ 27
Dabhol Power Company	30	-	-
Joint Energy Development Investments L.P.	11	(45)	68
Joint Energy Development Investments II, L.P.	92	(4)	-
Transportadora de Gas del Sur S.A.	32	36	45
Other	<u>119</u>	<u>87</u>	<u>76</u>
	<u>\$309</u>	<u>\$ 97</u>	<u>\$216</u>

Summarized combined financial information of Enron's unconsolidated affiliates is presented below:

(In millions)	December 31,	
	1999	1998
Balance sheet		
Current assets <sup>(a)</sup>	\$ 3,168	\$ 2,309
Property, plant and equipment, net	14,356	12,640
Other noncurrent assets	9,459	7,176
Current liabilities <sup>(a)</sup>	4,401	3,501
Long-term debt <sup>(a)</sup>	8,486	7,621
Other noncurrent liabilities	2,402	2,016
Owners' equity	<u>11,694</u>	<u>8,987</u>

(a) Includes \$327 million and \$196 million receivable from Enron and \$84 million and \$296 million payable to Enron at December 31, 1999 and 1998, respectively.

(In millions)	1999	1998	1997
Income statement <sup>(a)</sup>			
Operating revenues	\$11,568	\$8,508	\$11,183
Operating expenses	9,449	7,244	10,246
Net income	1,857	142	336
Distributions paid to Enron	482	87	118

(a) Enron recognized revenues from transactions with unconsolidated equity affiliates of \$161 million in 1999, \$142 million in 1998 and \$219 million in 1997.

In 1998, Enron, through a wholly-owned subsidiary, acquired Wessex Water Plc (Wessex), which provides water supply and wastewater services in southern England, for approximately \$2.4 billion. Wessex is held through Azurix Corp. As a result of a financial restructuring in late 1998 and a public offering in 1999, Enron has reduced its ownership in Azurix to 34%.

In 1997, Enron and a third-party investor contributed approximately \$579 million and \$500 million, respectively, for interests in Whitewing. Whitewing purchased 250,000 shares of Enron Series A Junior Convertible Preferred Stock (Series A Preferred Stock) from Enron. In March 1999, Whitewing was amended to allow, among other things, control to be shared equally between Enron and the third-party investor. Consequently, Whitewing was deconsolidated by Enron, resulting in an increase in Enron's investment in unconsolidated equity affiliates of approximately \$500 million, an increase in preferred stock of \$1.0 billion and a decrease in minority interests of \$500 million. In September 1999, Enron entered into a series of transactions that resulted in the restructuring of Whitewing, including the exchange of all outstanding shares of Series A Preferred Stock held by Whitewing for 250,000 shares of Enron Mandatorily Convertible Junior Preferred Stock, Series B (Series B Preferred Stock) (see Note 10). In addition, Enron entered into a Share Settlement Agreement under which Enron could be obligated, under certain circumstances, to deliver additional shares of common stock or Series B Preferred Stock to Whitewing for the amount that the market price of the converted Enron common shares is less than \$28 per share. The number of shares of Series B Preferred Stock authorized equals the number of shares necessary to satisfy Enron's obligation under the Share Settlement Agreement. Absent certain defaults or other specified events, Enron has the option to acquire the outside investors' interests. If Enron does not acquire the outside investors' interests before January 2003, or earlier upon certain specified events, Whitewing will liquidate its assets and dissolve.

From time to time, Enron has entered into various administrative service, management, construction, supply and operating agreements with its unconsolidated equity affiliates. Enron's management believes that its existing agreements and transactions are reasonable compared to those which could have been obtained from third parties.

## 10 PREFERRED STOCK

### Preferred Stock

Following Enron's reincorporation in Oregon on July 1, 1997, Enron has authorized 16,500,000 shares of preferred stock, no par value. At December 31, 1999, Enron had outstanding 1,296,184 shares of Cumulative Second Preferred Convertible Stock (the Convertible Preferred Stock), no par value. The Convertible Preferred Stock pays dividends at an amount equal to the higher of \$10.50 per share or the equivalent dividend that would be paid if shares of the Convertible Preferred Stock were converted to common stock. Each share of the Convertible Preferred Stock is convertible at any time at the option of the holder thereof into 27.304 shares of Enron's common stock, subject to certain adjustments. The Convertible Preferred Stock is currently

subject to redemption at Enron's option at a price of \$100 per share plus accrued dividends. During 1999, 1998 and 1997, 23,664 shares, 17,797 shares and 33,069 shares, respectively, of the Convertible Preferred Stock were converted into common stock.

In September 1999, Enron entered into a series of transactions that resulted in exchange of all outstanding shares of Series A Preferred Stock held by Whitewing for 250,000 shares of Series B Preferred Stock with a liquidation value of \$1.0 billion. The Series B Preferred Stock pays semi-annual cash dividends at an annual rate of 6.50%. Each share of Series B Preferred Stock is mandatorily convertible into 200 shares of Enron common stock on January 15, 2003 or earlier upon the occurrence of certain events. See Note 9.

In connection with the Elektro and Wessex financings, which yielded proceeds of approximately \$1.6 billion (see Notes 2 and 9, respectively), Enron committed to cause the sale of Enron convertible preferred stock, with the number of common shares issuable upon conversion determined based on future common stock prices, if certain debt obligations of the related entities acquiring such interests are defaulted upon, or in certain events, including, among other things, Enron's credit ratings falling below specified levels. If the sale of stock were not sufficient to retire such obligations, Enron would be liable for the shortfall. The obligations will mature in December 2000 and 2001 for Elektro and Wessex, respectively.

### Company-Obligated Preferred Securities of Subsidiaries

Summarized information for Enron's company-obligated preferred securities of subsidiaries is as follows:

(In millions, except per share amounts and shares)	December 31,		Liquidation Value Per Share
	1999	1998	
Enron Capital LLC			
8% Cumulative Guaranteed Monthly Income Preferred Shares (MIPS) (8,550,000 shares) <sup>(a)</sup>	\$ 214	\$ 214	\$ 25
Enron Capital Trust I			
8.3% Trust Originated Preferred Securities (8,000,000 preferred securities) <sup>(a)</sup>	200	200	25
Enron Capital Trust II			
8 1/8% Trust Originated Preferred Securities (6,000,000 preferred securities) <sup>(a)</sup>	150	150	25
Enron Capital Trust III			
Adjustable-Rate Capital Trust Securities (200,000 preferred securities) <sup>(b)</sup>	200	200	1,000
Enron Equity Corp.			
8.57% Preferred Stock (880 shares) <sup>(a)</sup>	88	88	100,000
7.39% Preferred Stock (150 shares) <sup>(a)(c)</sup>	15	15	100,000
Enron Capital Resources, L.P.			
9% Cumulative Preferred Securities, Series A (3,000,000 preferred securities) <sup>(a)</sup>	75	75	25
Other	58	59	
	\$1,000	\$1,001	

(a) Redeemable under certain circumstances after specified dates.

(b) Mature in 2046.

(c) Mandatorily redeemable in 2006.

## 11 COMMON STOCK

### Earnings Per Share

The computation of basic and diluted earnings per share is as follows:

(In millions, except per share amounts)	Year Ended December 31,		
	1999	1998	1997
Numerator:			
Basic			
Income before cumulative effect of accounting changes	\$ 1,024	\$ 703	\$ 105
Preferred stock dividends:			
Second Preferred Stock	(17)	(17)	(17)
Series A Preferred Stock	(30)	-	-
Series B Preferred Stock	(19)	-	-
Income available to common shareholders before cumulative effect of accounting changes	958	686	88
Cumulative effect of accounting changes	(131)	-	-
Income available to common share holders	\$ 827	\$ 686	\$ 88
Diluted			
Income available to common shareholders before cumulative effect of accounting changes	\$ 958	\$ 686	\$ 88
Effect of assumed conversion of dilutive securities:			
Second Preferred Stock <sup>(a)</sup>	17	17	-
Series A Preferred Stock <sup>(b)</sup>	-	-	-
Series B Preferred Stock <sup>(b)</sup>	-	-	-
Income before cumulative effect of accounting changes	975	703	88
Cumulative effect of accounting changes	(131)	-	-
Income available to common shareholders after assumed conversions	\$ 844	\$ 703	\$ 88
Denominator:			
Denominator for basic earnings per share – weighted-average shares	705	642	544
Effect of dilutive securities:			
Preferred stock <sup>(a)</sup>	36	36	-
Stock options	28	17	11
Dilutive potential common shares	64	53	11
Denominator for diluted earnings per share – adjusted weighted-average shares and assumed conversions	769	695	555
Basic earnings per share:			
Before cumulative effect of accounting changes	\$ 1.36	\$ 1.07	\$ 0.16
Cumulative effect of accounting changes	(0.19)	-	-
Basic earnings per share	\$ 1.17	\$ 1.07	\$ 0.16
Diluted earnings per share			
Before cumulative effect of accounting changes	\$ 1.27	\$ 1.01	\$ 0.16
Cumulative effect of accounting changes	(0.17)	-	-
Diluted earnings per share	\$ 1.10	\$ 1.01	\$ 0.16

(a) For 1997, the dividends and conversion of preferred stock have been excluded from the computation because the conversion is antidilutive.

(b) The Series A Preferred Stock and the Series B Preferred Stock were not included in the calculation of diluted earnings per share because conversion of these shares would be antidilutive (see Note 10).

On July 13, 1999, Enron announced a two-for-one common stock split effective August 13, 1999, to shareholders of record July 23, 1999. All share and per share amounts have been restated to reflect the stock split, and appropriate adjustments have been made in market prices of stock, conversion ratios of shares of convertible preferred stock and exercise price and number of shares subject to stock options. Effective with the stock split, the annual cash dividend rate on the common stock is \$0.50 per share.

### Forward Contracts and Options

At December 31, 1999, Enron had forward contracts to purchase 22.6 million shares of Enron Corp. common stock, including approximately 12 million shares with JEDI, at an average price of \$41.52 per share. Enron may purchase the shares pursuant to the forward contracts with cash or an equivalent value of Enron common stock until April 2001. Shares potentially deliverable to the counterparty under the contracts are assumed to be outstanding in calculating diluted earnings per share unless they are antidilutive. At December 31, 1999, Enron also had outstanding non-employee options to purchase 6.4 million shares of Enron common stock at an exercise price of \$19.59 per share.

### Stock Option Plans

Enron applies Accounting Principles Board (APB) Opinion 25 and related interpretations in accounting for its stock option plans. In accordance with APB Opinion 25, no compensation expense has been recognized for the fixed stock option plans. Compensation expense charged against income for the restricted stock plan for 1999, 1998 and 1997 was \$131 million, \$58 million and \$14 million, respectively. Had compensation cost for Enron's stock option compensation plans been determined based on the fair value at the grant dates for awards under those plans, Enron's net income and earnings per share would have been \$827 million (\$1.08 per share basic, \$1.01 per share diluted) in 1999, \$674 million (\$1.02 per share basic, \$0.97 per share diluted) in 1998 and \$66 million (\$0.09 per share basic, \$0.09 per share diluted) in 1997.

The fair value of each option grant is estimated on the date of grant using the Black-Scholes option-pricing model with weighted-average assumptions for grants in 1999, 1998 and 1997, respectively: (i) dividend yield of 2.4%, 2.5% and 2.5%; (ii) expected volatility of 20.0%, 18.3% and 17.4%; (iii) risk-free interest rates of 5.6%, 5.0% and 5.9%; and (iv) expected lives of 3.7 years, 3.8 years and 3.7 years.

Enron has four fixed option plans (the Plans) under which options for shares of Enron's common stock have been or may be granted to officers, employees and non-employee members of the Board of Directors. Options granted may be either incentive stock options or nonqualified stock options and are granted at not less than the fair market value of the stock at the time of grant. The Plans provide for options to be granted with a stock appreciation rights feature; however, Enron does not presently intend to issue options with this feature. Under the Plans, Enron may grant options with a maximum term of 10 years. Options vest under varying schedules.



Summarized information for Enron's Plans is as follows:

	1999		1998		1997	
	Shares	Weighted Average Exercise Price	Shares	Weighted Average Exercise Price	Shares	Weighted Average Exercise Price
(Shares in thousands)						
Outstanding, beginning of year	79,604	\$19.60	78,858	\$17.89	50,952	\$16.35
Granted	35,118	37.49	15,702	24.99	35,316	19.32
Exercised	(19,705)	18.08	(13,072)	15.70	(4,330)	11.65
Forfeited	(1,465)	24.51	(1,498)	19.77	(3,028)	17.63
Expired	(21)	18.79	(386)	19.76	(52)	17.30
Outstanding, end of year	93,531	26.74	79,604	19.60	78,858	17.89
Exercisable, end of year	52,803	22.56	45,942	\$18.16	42,504	\$16.78
Available for grant, end of year <sup>(a)</sup>	24,864		10,498		26,094	
Weighted average fair value of options granted		\$ 7.24		\$ 4.20		\$ 3.55

(a) Includes up to 22,140,962 shares, 10,497,670 shares and 24,492,080 shares as of December 31, 1999, 1998 and 1997, respectively, which may be issued either as restricted stock or pursuant to stock options.

The following table summarizes information about stock options outstanding at December 31, 1999 (shares in thousands):

	Options Outstanding		Options Exercisable		
	Number Outstanding at 12/31/99	Weighted Average Remaining Contractual Life	Weighted Average Exercise Price	Number Exercisable at 12/31/99	Weighted Average Exercise Price
Range of Exercise Prices					
\$ 6.58 to \$18.03	13,327	3.7	\$14.90	13,130	\$14.88
18.38 to 19.94	14,477	5.4	18.90	10,969	18.97
20.00 to 22.50	20,806	5.1	21.10	14,555	21.17
23.19 to 28.72	10,687	7.7	26.65	4,480	26.67
30.03 to 50.48	34,234	7.3	38.12	9,669	37.24
	93,531	6.1	\$26.74	52,803	\$22.56

#### Restricted Stock Plan

Under Enron's Restricted Stock Plan, participants may be granted stock without cost to the participant. The shares granted under this plan vest to the participants at various times ranging from immediate vesting to vesting at the end of a five-year period. Upon vesting, the shares are released to the participants. The following summarizes shares of restricted stock under this plan:

(Shares in thousands)	1999	1998	1997
Outstanding, beginning of year	6,034	5,074	1,650
Granted	2,672	2,122	4,176
Released to participants	(1,702)	(1,064)	(642)
Forfeited	(223)	(98)	(110)
Outstanding, end of year	6,781	6,034	5,074
Available for grant, end of year	22,141	10,498	24,492
Weighted average fair value of restricted stock granted	\$37.38	\$23.70	\$19.13

## 12 PENSION AND OTHER BENEFITS

Enron maintains a retirement plan (the Enron Plan) which is a non-contributory defined benefit plan covering substantially all employees in the United States and certain employees in foreign countries. The benefit accrual is in the form of a cash balance of 5% of annual base pay.

Portland General has a noncontributory defined benefit pension plan (the Portland General Plan) covering substantially all of its employees. Benefits under the Plan are based on years of service, final average pay and covered compensation.

Enron also maintains a noncontributory employee stock ownership plan (ESOP) which covers all eligible employees. Allocations to individual employees' retirement accounts within the ESOP offset a portion of benefits earned under the Enron Plan. All shares included in the ESOP have been allocated to the employee accounts. At December 31, 1999 and 1998, 17,241,731 shares and 21,838,100 shares, respectively, of Enron common stock were held by the ESOP, a portion of which may be used to offset benefits under the Enron Plan.

Assets of the Enron Plan and the Portland General Plan are comprised primarily of equity securities, fixed income securities and temporary cash investments. It is Enron's policy to fund all pension costs accrued to the extent required by federal tax regulations.

Enron provides certain postretirement medical, life insurance and dental benefits to eligible employees and their eligible dependents. Benefits are provided under the provisions of contributory defined dollar benefit plans. Enron is currently funding that portion of its obligations under these postretirement benefit plans which are expected to be recoverable through rates by its regulated pipelines and electric utility operations.

Enron accrues these postretirement benefit costs over the service lives of the employees expected to be eligible to receive such benefits. Enron is amortizing the transition obligation which existed at January 1, 1993 over a period of approximately 19 years.

The following table sets forth information related to changes in the benefit obligations, changes in plan assets, a reconciliation of the funded status of the plans and components of the expense recognized related to Enron's pension and other postretirement plans:

(In millions)	Pension Benefits		Other Benefits	
	1999	1998	1999	1998
Change in benefit obligation				
Benefit obligation, beginning of year	\$687	\$617	\$134	\$148
Service cost	32	27	2	2
Interest cost	49	44	9	9
Plan participants' contributions	-	-	3	3
Plan amendments	6	-	-	3
Actuarial loss (gain)	(51)	26	(12)	(16)
Acquisitions and divestitures	36	-	-	-
Effect of curtailment and settlements <sup>(a)</sup>	(8)	-	-	-
Benefits paid	(43)	(27)	(16)	(15)
Benefit obligation, end of year	\$708	\$687	\$120	\$134

Change in plan assets				
Fair value of plan assets, beginning of year <sup>(b)</sup>	\$774	\$727	\$ 60	\$ 54
Actual return on plan assets	80	41	7	3
Acquisitions and divestitures	37	-	-	-
Employer contribution	5	33	6	8
Plan participants' contributions	-	-	3	3
Benefits paid	(43)	(27)	(8)	(8)
Fair value of plan assets, end of year <sup>(b)</sup>	\$853	\$774	\$ 68	\$ 60

Reconciliation of funded status, end of year				
Funded status, end of year	\$145	\$ 87	\$ (52)	\$ (74)
Unrecognized transition obligation (asset)	(13)	(18)	48	58
Unrecognized prior service cost	32	33	14	17
Unrecognized net actuarial loss (gain)	11	79	(29)	(10)
Prepaid (accrued) benefit cost	\$175	\$181	\$ (19)	\$ (9)

Weighted-average assumptions at December 31	1999	1998	1999	1998
Discount rate	7.75%	6.75%	7.75%	6.75%
Expected return on plan assets (pre-tax)	(c)	(c)	(d)	(d)
Rate of compensation increase	(e)	(e)	(e)	(e)

Components of net periodic benefit cost				
Service cost	\$ 32	\$ 27	\$ 2	\$ 2
Interest cost	49	44	9	9
Expected return on plan assets	(70)	(63)	(4)	(3)
Amortization of transition obligation (asset)	(6)	(6)	4	4
Amortization of prior service cost	5	5	1	1
Recognized net actuarial loss (gain)	3	2	-	-
Effect of curtailment and settlements <sup>(a)</sup>	(6)	-	6	-
Net periodic benefit cost	\$ 7	\$ 9	\$ 18	\$ 13

(a) Represents one-time nonrecurring events associated with the exchange and sale of EOG (see Note 2) and with certain employees ceasing participation in the Portland General Plan as a result of union negotiations.

(b) Includes plan assets of the ESOP of \$121 million and \$139 million at December 31, 1999 and 1998, respectively.

(c) Long-term rate of return on assets is assumed to be 10.5% for the Enron Plan and 9.0% for the Portland General Plan.

(d) Long-term rate of return on assets is assumed to be 7.5% for the Enron assets and 9.5% for the Portland General assets.

(e) Rate of compensation increase is assumed to be 4.0% for the Enron Plan and 4.0% to 9.5% for the Portland General Plan.

Included in the above amounts are the unfunded obligations for the supplemental executive retirement plans. At December 31, 1999 and 1998, respectively, the projected benefit obligation for these unfunded plans was \$56 million and \$57 million and the fair value of assets was \$1 million and \$2 million.

The measurement date of the Enron Plan and the ESOP is September 30, and the measurement date of the Portland General Plan and the postretirement benefit plans is December 31. The funded status

as of the valuation date of the Enron Plan, the Portland General Plan, the ESOP and the postretirement benefit plans reconciles with the amount detailed above which is included in "Other Assets" on the Consolidated Balance Sheet.

For measurement purposes, 6% and 10% annual rates of increase in the per capita cost of covered health care benefits were assumed in 2000 for the Enron and Portland General postretirement plans, respectively. The rates were assumed to decrease to 5% by 2001 and 2010 for the Enron and Portland General postretirement plans, respectively. Assumed health care cost trend rates have a significant effect on the amounts reported for the health care plans. A one-percentage-point change in assumed health care cost trend rates would have the following effects:

(In millions)	1-Percentage Point Increase	1-Percentage Point Decrease
Effect on total of service and interest cost components	\$0.4	\$(0.3)
Effect on postretirement benefit obligation	\$5.2	\$(4.7)

Additionally, certain Enron subsidiaries maintain various incentive based compensation plans for which participants may receive a combination of cash or stock options of the subsidiaries, based upon the achievement of certain performance goals.

### 13 RATES AND REGULATORY ISSUES

Rates and regulatory issues related to certain of Enron's natural gas pipelines and its electric utility operations are subject to final determination by various regulatory agencies. The domestic interstate pipeline operations are regulated by the Federal Energy Regulatory Commission (FERC) and the electric utility operations are regulated by the FERC and the Oregon Public Utility Commission (OPUC). As a result, these operations are subject to the provisions of Statement of Financial Accounting Standards (SFAS) No. 71, "Accounting for the Effects of Certain Types of Regulation," which recognizes the economic effects of regulation and, accordingly, Enron has recorded regulatory assets and liabilities related to such operations.

The regulated pipelines operations' net regulatory assets were \$250 million and \$241 million at December 31, 1999 and 1998, respectively, and are expected to be recovered over varying time periods.

The electric utility operations' net regulatory assets were \$494 million at December 31, 1999 and 1998. Based on rates in place at December 31, 1999, Enron estimates that it will collect substantially all of its regulatory assets within the next 12 years.

#### Pipeline Operations

On May 1, 1998, Northern Natural Gas Company (Northern) filed a general rate case proceeding with the FERC which fulfilled a commitment made in a previous settlement. The FERC accepted the rate case for filing and suspended the filed rates. Northern implemented the filed rates effective November 1, 1998, subject to refund. An uncontested Stipulation and Agreement of Settlement (Settlement) was filed with the Commission on April 16, 1999 and an order approving the Settlement was issued by the Commission on June 18, 1999. Northern issued refunds on September 1, 1999. Northern effectuated new rates, which reflected seasonality, on November 1, 1999.

On November 1, 1999, Transwestern Pipeline Company implemented a rate escalation of settled transportation rates in accordance with its May 1995 global settlement, as amended in May 1996.

## Electric Utility Operations

PGE is a 67.5% owner of the Trojan Nuclear Plant (Trojan). In March 1995, the OPUC issued an order authorizing PGE to recover all of the estimated costs of decommissioning Trojan and 87% of its remaining investment in the plant. At December 31, 1999, PGE's regulatory asset related to recovery of Trojan costs from customers was \$398 million. Amounts are to be collected over Trojan's original license period ending in 2011. An effort is being made to negate new legislation allowing PGE's recovery of a return on its undepreciated investment in Trojan, and a referendum will appear on the November 2000 ballot. See Note 14.

Enron believes, based upon its experience to date and after considering appropriate reserves that have been established, that the ultimate resolution of pending regulatory matters will not have a material impact on Enron's financial position or results of operations.

## 14 LITIGATION AND OTHER CONTINGENCIES

Enron is a party to various claims and litigation, the significant items of which are discussed below. Although no assurances can be given, Enron believes, based on its experience to date and after considering appropriate reserves that have been established, that the ultimate resolution of such items, individually or in the aggregate, will not have a material adverse impact on Enron's financial position or its results of operations.

### Litigation

In 1995, several parties (the Plaintiffs) filed suit in Harris County District Court in Houston, Texas, against Intratex Gas Company (Intratex), Houston Pipe Line Company and Panhandle Gas Company (collectively, the Enron Defendants), each of which is a wholly-owned subsidiary of Enron. The Plaintiffs were either sellers or royalty owners under numerous gas purchase contracts with Intratex, many of which have terminated. Early in 1996, the case was severed by the Court into two matters to be tried (or otherwise resolved) separately. In the first matter, the Plaintiffs alleged that the Enron Defendants committed fraud and negligent misrepresentation in connection with the "Panhandle program," a special marketing program established in the early 1980s. This case was tried in October 1996 and resulted in a verdict for the Enron Defendants. In the second matter, the Plaintiffs allege that the Enron Defendants violated state regulatory requirements and certain gas purchase contracts by failing to take the Plaintiffs' gas ratably with other producers' gas at certain times between 1978 and 1988. The trial court has certified a class action with respect to ratable claims. On April 30, 1999, the Texas Supreme Court granted Enron's petition for review and agreed to consider Enron's appeal of the class certification. The Enron Defendants deny the Plaintiffs' claims and have asserted various affirmative defenses, including the statute of limitations. The Enron Defendants believe that they have strong legal and factual defenses, and intend to vigorously contest the claims. Although no assurances can be given, Enron believes that the ultimate resolution of these matters will not have a material adverse effect on its financial position or results of operations.

On November 21, 1996, an explosion occurred in or around the Humberto Vidal Building in San Juan, Puerto Rico. The explosion resulted in fatalities, bodily injuries and damage to the building and surrounding property. San Juan Gas Company, Inc. (San Juan), an Enron subsidiary, operated a propane/air distribution system in the vicinity. Although San Juan did not provide service to the building, the National Transportation Safety Board (NTSB) concluded that the probable cause of the incident was propane leaking from San Juan's distribution system. San Juan and Enron strongly disagree. The NTSB found no path of migration of propane from San Juan's system to the building and no forensic evidence that propane fueled the explosion. Enron, San Juan, and four

San Juan affiliates have been named, along with several third parties, as defendants in numerous lawsuits filed in U.S. District Court for the district of Puerto Rico and the Superior Court of Puerto Rico. These suits, which seek damages for wrongful death, personal injury, business interruption and property damage, allege that negligence of Enron, San Juan and its affiliates, among others, caused the explosion. Enron, San Juan and its affiliates are vigorously contesting the claims. Although no assurances can be given, Enron believes that the ultimate resolution of these matters will not have a material adverse effect on its financial position or results of operations.

### Trojan Investment Recovery

In early 1993, PGE ceased commercial operation of Trojan. In April 1996 a circuit court judge in Marion County, Oregon, found that the OPUC could not authorize PGE to collect a return on its undepreciated investment in Trojan, contradicting a November 1994 ruling from the same court. The ruling was the result of an appeal of PGE's March 1995 general rate order which granted PGE recovery of, and a return on, 87% of its remaining investment in Trojan. The 1994 ruling was appealed to the Oregon Court of Appeals and was stayed pending the appeal of the OPUC's March 1995 order. Both PGE and the OPUC have separately appealed the April 1996 ruling, which appeals were combined with the appeal of the November 1994 ruling at the Oregon Court of Appeals. On June 24, 1998, the Court of Appeals of the State of Oregon ruled that the OPUC does not have the authority to allow PGE to recover a rate of return on its undepreciated investment in the Trojan generating facility. The court upheld the OPUC's authorization of PGE's recovery of its undepreciated investment in Trojan.

PGE and the OPUC each filed petitions for review with the Oregon Supreme Court. On August 26, 1998, the Utility Reform Project filed a petition for review with the Oregon Supreme Court seeking review of that portion of the Oregon Court of Appeals decision relating to PGE's recovery of its undepreciated investment in Trojan. On April 29, 1999, the Oregon Supreme Court accepted the petitions for review. On June 16, 1999, Oregon House Bill 3220 authorizing the OPUC to allow recovery of a return on the undepreciated investment in property retired from service was signed. One of the effects of the bill is to affirm retroactively the OPUC's authority to allow PGE's recovery of a return on its undepreciated investment in the Trojan generating facility.

Relying on the new legislation, on July 2, 1999, PGE requested the Oregon Supreme Court to vacate the June 24, 1998, adverse ruling of the Oregon Court of Appeals, affirm the validity of the OPUC's order allowing PGE to recover a return on its undepreciated investment in Trojan and to reverse its decision accepting the Utility Reform Project's petition for review. The Utility Reform Project and the Citizens Utility Board, another party to the proceeding, opposed such request and submitted to the Oregon Secretary of State sufficient signatures in support of placing a referendum to negate the new legislation on the November 2000 ballot. The Oregon Supreme Court has indicated it will defer hearing the matter until after the November 2000 elections. Enron cannot predict the outcome of these actions. Additionally, due to uncertainties in the regulatory process, management cannot predict, with certainty, what ultimate rate-making action the OPUC will take regarding PGE's recovery of a rate of return on its Trojan investment. Although no assurances can be given, Enron believes that the ultimate resolution of these matters will not have a material adverse effect on its financial position or results of operations.

## Environmental Matters

Enron is subject to extensive federal, state and local environmental laws and regulations. These laws and regulations require expenditures in connection with the construction of new facilities, the operation of existing facilities and for remediation at various operating sites. The implementation of the Clean Air Act Amendments is expected to result in increased operating expenses. These increased operating expenses are not expected to have a material impact on Enron's financial position or results of operations.

The Environmental Protection Agency (EPA) has informed Enron that it is a potentially responsible party at the Decorah Former Manufactured Gas Plant Site (the Decorah Site) in Decorah, Iowa, pursuant to the provisions of the Comprehensive Environmental Response, Compensation and Liability Act (CERCLA, also commonly known as Superfund). The manufactured gas plant in Decorah ceased operations in 1951. A predecessor company of Enron purchased the Decorah Site in 1963. Enron's predecessor did not operate the gas plant and sold the Decorah Site in 1965. The EPA alleges that hazardous substances were released to the environment during the period in which Enron's predecessor owned the site, and that Enron's predecessor assumed the liabilities of the company that operated the plant. Enron contests these allegations. To date, the EPA has identified no other potentially responsible parties with respect to this site. Under the terms of administrative orders, Enron replaced affected topsoil and removed impacted subsurface soils in certain areas of the tract where the plant was formerly located. Enron completed the final removal actions at the site in November 1998 and concluded all remaining site activities in the spring of 1999. Enron submitted a final report on the work conducted at the site to the EPA. Enron does not expect to incur material expenditures in connection with this site.

Enron also received from the EPA an Order issued under CERCLA alleging that Enron and two other parties are responsible for the cost of demolition and proper disposal of two 110 foot towers that apparently had been used in the manufacture of carbon dioxide at a site called the "City Bumper Site" in Cincinnati, Ohio. The carbon dioxide plant, according to agency documents, was in operation from 1926 to 1966. Houston Natural Gas Corporation, a predecessor of Enron Corp., merged with Liquid Carbonic Industries (LCI) on January 31, 1969. Liquid Carbonic Corporation (LCC), a subsidiary of LCI, had title to the site. Twenty-eight days after the merger, on February 28, 1969, the site was sold to a third party. In 1984, LCC was sold to an unaffiliated party in a stock sale. Although Enron does not admit liability with respect to any costs at this site, it agreed to cooperate with the EPA and other potentially responsible parties to undertake the work contemplated by the EPA's Order. The tower demolition and removal activities were completed in October 1998, and a final project report has been submitted to the EPA. The EPA has confirmed through correspondence that all activities required by the order are complete.

Enron's natural gas pipeline companies conduct soil and ground water remediation on a number of their facilities. Enron does not expect to incur material expenditures in connection with soil and groundwater remediation.

## 15 COMMITMENTS

### Firm Transportation Obligations

Enron has firm transportation agreements with various joint venture pipelines. Under these agreements, Enron must make specified minimum payments each month. At December 31, 1999, the estimated aggregate amounts of such required future payments were \$65 million, \$68 million, \$69 million, \$70 million and \$74 million for 2000 through 2004, respectively, and \$515 million for later years.

The costs recognized under firm transportation agreements, including commodity charges on actual quantities shipped, totaled \$55 million, \$30 million and \$27 million in 1999, 1998 and 1997, respectively. Enron has assigned firm transportation contracts with two of its joint ventures to third parties and guaranteed minimum payments under the contracts averaging approximately \$36 million annually through 2001 and \$3 million in 2002.

### Other Commitments

Enron leases property, operating facilities and equipment under various operating leases, certain of which contain renewal and purchase options and residual value guarantees. Future commitments related to these items at December 31, 1999 were \$266 million, \$88 million, \$78 million, \$53 million and \$48 million for 2000 through 2004, respectively, and \$370 million for later years. Guarantees under the leases total \$715 million at December 31, 1999.

Total rent expense incurred during 1999, 1998 and 1997 was \$143 million, \$147 million and \$156 million, respectively.

In November 1999, a subsidiary of Enron made a contribution lease-back of assets in return for a preferred interest in an unconsolidated equity affiliate of Enron. As a result of this transaction, Enron has net future obligations of \$5 million each year for 2000 through 2004 and \$49 million thereafter.

Enron guarantees the performance of certain of its unconsolidated equity affiliates in connection with letters of credit issued on behalf of those entities. At December 31, 1999, a total of \$303 million of such guarantees were outstanding, including \$144 million on behalf of EOTT. In addition, Enron is a guarantor on certain liabilities of unconsolidated equity affiliates and other companies totaling approximately \$1,501 million at December 31, 1999, including \$427 million related to EOTT trade obligations. The EOTT letters of credit and guarantees of trade obligations are secured by the assets of EOTT. Enron has also guaranteed \$420 million in lease obligations for which it has been indemnified by an "Investment Grade" company. Management does not consider it likely that Enron would be required to perform or otherwise incur any losses associated with the above guarantees. In addition, certain commitments have been made related to capital expenditures and equity investments planned in 2000.

In June 1999, Enron entered into a series of transactions involving a third party and LJM Cayman, L.P. (LJM). LJM is a private investment company which engages in acquiring or investing in primarily energy-related investments. A senior officer of Enron is the managing member of LJM's general partner. The effect of the transactions was (i) Enron and the third party amended certain forward contracts to purchase shares of Enron common stock, resulting in Enron having forward contracts to purchase Enron common shares at the market price on that day, (ii) LJM received 6.8 million shares of Enron common stock subject to certain restrictions and (iii) Enron received a note receivable and certain financial instruments hedging an investment held by Enron. Enron recorded the assets received and equity issued at estimated fair value. In connection with the transactions, LJM agreed that the Enron officer would have no pecuniary interest in such Enron common shares and would be restricted from voting on matters related to such shares. LJM repaid the note receivable in December 1999.

LJM2 Co-Investment, L.P. (LJM2) was formed in December 1999 as a private investment company which engages in acquiring or investing in primarily energy-related or communications-related businesses. In the fourth quarter of 1999, LJM2, which has the same general partner as LJM, acquired, directly or indirectly, approximately \$360 million of merchant assets and investments from Enron, on which Enron recognized pre-tax gains of approximately \$16 million. In December 1999, LJM2 entered into an agreement to acquire Enron's interests in an unconsolidated equity affiliate for approximately \$34 million. Additionally, LJM acquired other assets from Enron for \$11 million.

At December 31, 1999, JEDI held approximately 12 million shares of Enron Corp. common stock. The value of the Enron Corp. common stock has been hedged. In addition, an officer of Enron has invested in the limited partner of JEDI and from time to time acts as agent on behalf of the limited partner's management.

In 1999, Whitewing acquired approximately \$192 million of merchant assets from Enron. Enron recognized no gains or losses in connection with these transactions.

Management believes that the terms of the transactions with related parties are representative of terms that would be negotiated with unrelated third parties.

## 17 ASSET IMPAIRMENT

Continued significant changes in state and federal rules regarding the use of MTBE as a gasoline additive have significantly impacted Enron's view of the future prospects for this business. As a result, Enron completed a reevaluation of its position and strategy with respect to its operated MTBE assets which resulted in (i) the purchase of certain previously-leased MTBE related assets, under provisions within the lease, in order to facilitate future actions, including the potential disposal of such assets and (ii) a review of all MTBE-related assets for impairment considering the recent adverse changes and their impact on recoverability. Based on this review and disposal discussions with market participants, in September 1999, Enron recorded a \$441 million pre-tax charge for the impairment of its MTBE-related assets.

### Cumulative Effect of Accounting Changes

In the first quarter of 1999, Enron recorded an after-tax charge of \$131 million to reflect the initial adoption (as of January 1, 1999) of two new accounting pronouncements. In 1998, the AICPA issued Statement of Position 98-5 (SOP 98-5), "Reporting on the Costs of Start-Up Activities," which requires that costs for all start-up activities and organization costs be expensed as incurred and not capitalized in certain instances, as had previously been allowed. Also in 1998, the Emerging Issues Task Force reached consensus on Issue No. 98-10, "Accounting for Contracts Involved in Energy Trading and Risk Management Activities," requiring energy trading contracts, including energy transportation contracts, to be recorded at fair value on the balance sheet, with the changes in fair value included in earnings. The first quarter 1999 charge was primarily related to the adoption of SOP 98-5.

### Recently Issued Accounting Pronouncements

In 1998, the Financial Accounting Standards Board issued SFAS No. 133, "Accounting for Derivative Instruments and Hedging Activities." SFAS No. 133 establishes accounting and reporting standards requiring that every derivative instrument (including certain derivative instruments embedded in other contracts) be recorded on the balance sheet as either an asset or liability measured at its fair value. The statement requires that changes in the derivative's fair value be recognized currently in earnings unless specific hedge accounting criteria are met. Special accounting for qualifying hedges allows a derivative's gains and losses to offset related results on the hedged item in the income statement, and requires that a company must formally document, designate and assess the effectiveness of transactions that receive hedge accounting.

In June 1999, the FASB issued SFAS No. 137, which deferred the effective date of SFAS No. 133 to fiscal years beginning after June 15, 2000. A company may implement SFAS No. 133 as of the beginning of any fiscal quarter after issuance, however, the statement cannot be applied retroactively. Enron does not plan to early adopt SFAS No. 133. Enron believes that SFAS No. 133 will not have a material impact on its accounting for price risk management activities but has not yet quantified the effect on its hedging activities or physical based contracts.

## 19 QUARTERLY FINANCIAL DATA (Unaudited)

Summarized quarterly financial data is as follows:

(In millions, except per share amounts)	First Quarter	Second Quarter	Third Quarter	Fourth Quarter	Total Year <sup>(a)</sup>
<b>1999</b>					
Revenues	\$7,632	\$9,672	\$11,835	\$10,973	\$40,112
Income before interest, minority interests and income taxes	533	469	520	473	1,995
Net income	122	222	290	259	893
Earnings per share:					
Basic	\$ 0.17	\$ 0.29	\$ 0.38	\$ 0.33	\$ 1.17
Diluted	0.16	0.27	0.35	0.31	1.10
<b>1998</b>					
Revenues	\$5,682	\$6,557	\$11,320	\$ 7,701	\$31,260
Income before interest, minority interests and income taxes	471	345	405	361	1,582
Net income	214	145	168	176	703
Earnings per share:					
Basic	\$ 0.34	\$ 0.22	\$ 0.25	\$ 0.26	\$ 1.07
Diluted	0.32	0.21	0.24	0.25	1.01

(a) The sum of earnings per share for the four quarters may not equal earnings per share for the total year due to changes in the average number of common shares outstanding.

## 20 GEOGRAPHIC AND BUSINESS SEGMENT INFORMATION

Enron's business is divided into operating segments, defined as components of an enterprise about which financial information is available and evaluated regularly by the chief operating decision maker, or decision-making group, in deciding how to allocate resources to an individual segment and in assessing performance of the segment. Enron's chief operating decision-making group is the Office of the Chairman, which consists of the Chairman, President and Vice Chairman.

Enron's chief operating decision-making group evaluates performance and allocates resources based on income before interest, minority interests and income taxes (IBIT) as well as on net income. However, interest on corporate debt is primarily maintained at Corporate and is not allocated to the segments. Therefore, management believes that IBIT is the dominant measurement of segment profits consistent with Enron's consolidated financial statements. The accounting policies of the segments are substantially the same as those described in the summary of significant accounting policies in Note 1.

Enron has divided its operations into the following reportable segments, based on similarities in economic characteristics, products and services, types of customers, methods of distributions and regulatory environment.

**Transportation and Distribution** – Regulated industries. Interstate transmission of natural gas. Management and operation of pipelines. Electric utility operations.

**Wholesale Energy Operations and Services** – Energy commodity sales and services, risk management products and financial services to wholesale customers. Development, acquisition and operation of power plants, natural gas pipelines and other energy-related and communications assets including broadband services.

**Retail Energy Services** – Sales of natural gas and electricity directly to end-use customers, particularly in the commercial and industrial sectors, including the outsourcing of energy-related activities.

**Exploration and Production** – Natural gas and crude oil exploration and production primarily in the United States, Canada, Trinidad and India until August 16, 1999. See Note 2.

**Corporate and Other** – Includes operation of water and renewable energy businesses as well as clean fuels plants.

Financial information by geographic and business segment follows for each of the three years in the period ended December 31, 1999.

### Geographic Segments

(In millions)	Year Ended December 31,		
	1999	1998	1997
Operating revenues from unaffiliated customers			
United States	\$30,176	\$25,247	\$17,328
Foreign	9,936	6,013	2,945
	<u>\$40,112</u>	<u>\$31,260</u>	<u>\$20,273</u>
Income (loss) before interest, minority interests and income taxes			
United States	\$ 1,273	\$ 1,008	\$ 601
Foreign	722	574	(36)
	<u>\$ 1,995</u>	<u>\$ 1,582</u>	<u>\$ 565</u>
Long-lived assets			
United States	\$ 8,286	\$ 9,382	\$ 8,425
Foreign	2,395	1,275	745
	<u>\$10,681</u>	<u>\$10,657</u>	<u>\$ 9,170</u>

## Business Segments

(In millions)	Transportation and Distribution	Wholesale Energy Operations and Services	Retail Energy Services	Exploration and Production <sup>(c)</sup>	Corporate and Other <sup>(d)</sup>	Total
<b>1999</b>						
Unaffiliated revenues <sup>(a)</sup>	\$2,013	\$35,501	\$1,518	\$ 429	\$ 651	\$40,112
Intersegment revenues <sup>(b)</sup>	19	786	289	97	(1,191)	-
Total revenues	2,032	36,287	1,807	526	(540)	40,112
Depreciation, depletion and amortization	246	294	29	213	88	870
Operating income (loss)	551	889	(81)	66	(623)	802
Equity in earnings of unconsolidated equity affiliates	50	237	-	-	22	309
Gains on sales of assets and investments	19	11	-	-	511	541
Interest income	20	126	5	-	11	162
Other income, net	45	54	8	(1)	75	181
Income (loss) before interest, minority interests and income taxes	685	1,317	(68)	65	(4)	1,995
Capital expenditures	316	1,216	64	226	541	2,363
Identifiable assets	7,148	18,501	956	-	1,740	28,345
Investments in and advances to unconsolidated equity affiliates	811	2,684	-	-	1,541	5,036
Total assets	\$7,959	\$21,185	\$ 956	\$ -	\$ 3,281	\$33,381
<b>1998</b>						
Unaffiliated revenues <sup>(a)</sup>	\$1,833	\$27,220	\$1,072	\$ 750	\$ 385	\$31,260
Intersegment revenues <sup>(b)</sup>	16	505	-	134	(655)	-
Total revenues	1,849	27,725	1,072	884	(270)	31,260
Depreciation, depletion and amortization	253	195	31	315	33	827
Operating income (loss)	562	880	(124)	133	(73)	1,378
Equity in earnings of unconsolidated equity affiliates	33	42	(2)	-	24	97
Gains on sales of assets and investments	31	4	-	-	21	56
Interest income	9	67	-	1	11	88
Other income, net	2	(25)	7	(6)	(15)	(37)
Income (loss) before interest, minority interests and income taxes	637	968	(119)	128	(32)	1,582
Capital expenditures	310	706	75	690	124	1,905
Identifiable assets	6,955	12,205	747	3,001	2,009	24,917
Investments in and advances to unconsolidated equity affiliates	661	2,632	-	-	1,140	4,433
Total assets	\$7,616	\$14,837	\$ 747	\$3,001	\$ 3,149	\$29,350
<b>1997</b>						
Unaffiliated revenues <sup>(a)</sup>	\$1,402	\$17,344	\$ 683	\$ 789	\$ 55	\$20,273
Intersegment revenues <sup>(b)</sup>	14	678	2	108	(802)	-
Total revenues	1,416	18,022	685	897	(747)	20,273
Depreciation, depletion and amortization	160	133	7	278	22	600
Operating income (loss)	398	376	(105)	185	(839)	15
Equity in earnings of unconsolidated equity affiliates	40	172	(1)	-	5	216
Gains on sales of assets and investments	120	(1)	-	-	67	186
Interest income	8	57	-	1	4	70
Other income, net	14	50	(1)	(3)	18	78
Income (loss) before interest, minority interests and income taxes	580	654	(107)	183	(745)	565
Capital expenditures	337	318	36	626	75	1,392
Identifiable assets	7,115	8,661	322	2,668	1,130	19,896
Investments in and advances to unconsolidated equity affiliates	521	1,932	-	-	203	2,656
Total assets	\$7,636	\$10,593	\$ 322	\$2,668	\$ 1,333	\$22,552

(a) Unaffiliated revenues include sales to unconsolidated equity affiliates.

(b) Intersegment sales are made at prices comparable to those received from unaffiliated customers and in some instances are affected by regulatory considerations.

(c) Reflects results through August 16, 1999. See Note 2.

(d) Includes consolidating eliminations.

## Selected Financial and Credit Information (Unaudited)

The following review of the credit characteristics of Enron Corp. and its subsidiaries and affiliates should be read in conjunction with the Consolidated Financial Statements. The credit information that follows represents management's calculation of certain key credit ratios of Enron.

(In millions)	1999	1998	Source
<b>Total Obligations</b>			
Balance sheet debt (short- and long-term)	\$ 8,152	\$ 7,357	Balance Sheet
Items added to liability profile:			
Accounts receivable sales <sup>(a)</sup>	-	202	
Guarantees <sup>(b)</sup>	180	96	Note 15
Residual value guarantees of synthetic leases	715	1,039	Note 15
Net liability from price risk management activities <sup>(c)</sup>	-	87	Balance Sheet
Debt exchangeable for EOG Resources, Inc. shares <sup>(d)</sup>	(239)	-	Note 7
Debt of unconsolidated equity affiliates <sup>(e)</sup>	-	-	Note 9
Firm transportation obligations <sup>(f)</sup>	-	-	Note 15
<b>Total Obligations</b>	<b>\$ 8,808</b>	<b>\$ 8,781</b>	
<b>Shareholders' Equity and Certain Other Items</b>			
Shareholders' Equity	\$ 9,570	\$ 7,048	Balance sheet
Items added to shareholders' equity:			
Minority interests	2,430	2,143	Balance Sheet, Note 8
Company-obligated preferred securities of subsidiaries	1,000	1,001	Balance Sheet, Note 10
<b>Total Shareholders' Equity and Certain Other Items</b>	<b>\$13,000</b>	<b>\$10,192</b>	
<b>Funds Flow from Operations</b>			
Net cash provided by operating activities	\$ 1,228	\$ 1,640	Cash Flow Statement
Add back: Changes in working capital	(1,000)	(233)	Cash Flow Statement
<b>Funds Flow from Operations</b>	<b>\$ 2,228</b>	<b>\$ 1,873</b>	
<b>Interest and Estimated Lease Interest Expense</b>			
Interest incurred	\$ 710	\$ 616	
Capitalized interest	(54)	(66)	Management's Discussion and Analysis
<b>Interest and Related Charges, net</b>	<b>\$ 656</b>	<b>\$ 550</b>	Income Statement
<b>Estimated Lease Interest Expense<sup>(g)</sup></b>	<b>\$ 124</b>	<b>\$ 125</b>	
<b>Adjusted Earnings for Credit Analysis</b>			
Income before interest, minority interests and income taxes	\$ 1,995	\$ 1,582	Income Statement
Adjustments to IBIT:			
Gain on sales of assets and investments	(541)	(82)	Cash Flow Statement
Impairment of long-lived assets	441	-	Cash Flow Statement
Distributions in excess of (less than) earnings of unconsolidated equity affiliates	173	(10)	Note 9
Estimated lease interest expense <sup>(g)</sup>	124	125	
<b>Total Adjusted Earnings for Credit Analysis</b>	<b>\$ 2,192</b>	<b>\$ 1,615</b>	
<b>Key Credit Ratios</b>			
Funds flow interest coverage <sup>(h)</sup>	3.67	3.53	
Pretax interest coverage <sup>(i)</sup>	2.63	2.18	
Funds flow from operations/Total obligations	25.3%	21.3%	
Total obligations/Total obligations plus Total shareholders' equity and certain other items	40.4%	46.3%	
Debt/Total capital <sup>(j)</sup>	38.5%	41.9%	

(a) Accounts receivable sold under agreements to provide financing to meet seasonal working capital needs.

(b) Management estimates Enron's risk adjusted exposure on uncollateralized guarantees is approximately 10% of the total nominal value of the guarantees issued.

(c) Excess of price risk management liabilities over price risk management assets.

(d) Enron expects to extinguish this obligation by delivering shares of EOG Resources, Inc. stock.

(e) Debt of unconsolidated equity affiliates is non-recourse and therefore is excluded from Enron's obligations.

(f) Firm transportation obligations are excluded, as contracted capacity has market value.

(g) Management estimates Enron's lease interest expense for the year based on the average minimum lease payment or commitment (excluding principal repayments and other items).

(h) Calculated as funds flow from operations plus interest incurred and estimated lease interest expense, divided by interest incurred and estimated lease interest expense.

(i) Calculated as total adjusted earnings divided by interest incurred and estimated lease interest expense.

(j) Total capital includes debt, minority interests, company-obligated preferred securities of subsidiaries and shareholders' equity.



## ENRON OFFICES

### CORPORATE HEADQUARTERS

Enron Corp.  
1400 Smith Street  
Houston, TX 77002  
Tel: (713) 853-6161  
www.enron.com

### WHOLESALE ENERGY BUSINESSES

#### North America

**Enron North America Corp.**  
Calgary, Canada  
Charleston, West Virginia  
Chicago, Illinois  
Denver, Colorado  
Houston, Texas  
Mexico City, Mexico  
Monterrey, Mexico  
New York, New York  
Pittsburgh, Pennsylvania  
Portland, Oregon  
San Francisco, California  
Toronto, Canada

#### Europe

**Enron Europe, Ltd.**  
Amsterdam, The Netherlands  
Brussels, Belgium  
Bucharest, Romania  
Budapest, Hungary  
Frankfurt, Germany  
Helsinki, Finland  
London, United Kingdom\*  
Madrid, Spain  
Milan, Italy  
Moscow, Russia  
Oslo, Norway  
Stockholm, Sweden  
Warsaw, Poland  
Zurich, Switzerland  
*\*Corporate headquarters in Europe*

#### South America, Latin America and Caribbean Basin

Bogotá, Colombia  
Buenos Aires, Argentina  
Caracas, Venezuela  
Kingston, Jamaica  
Managua, Nicaragua  
Nivel, Guatemala  
Panamá City, Panamá  
Rio de Janeiro, Brazil  
San Juan, Puerto Rico  
Santa Cruz, Bolivia  
Santo Domingo, Dominican Republic  
São Paulo, Brazil

#### Africa, Middle East and Asia

Anigua, Guam  
Bangkok, Thailand  
Beijing, China  
Dubai, United Arab Emirates  
Hanoi, Vietnam  
Jakarta, Indonesia  
Manila, Philippines  
Maputo, Mozambique  
Mumbai, India

New Delhi, India  
Sandton, South Africa  
Seoul, Korea  
Singapore  
Sydney, Australia  
Tokyo, Japan

### ENRON BROADBAND SERVICES

Houston, Texas  
Portland, Oregon

### RETAIL ENERGY SERVICES

**Enron Energy Services, LLC**  
Burlington, Massachusetts  
Costa Mesa, California  
Hinsdale, Illinois  
Houston, Texas  
Norcross, Georgia  
Philadelphia, Pennsylvania  
San Ramon, California

### TRANSPORTATION AND DISTRIBUTION

**Enron Transportation & Storage**  
Minneapolis, Minnesota  
Omaha, Nebraska

**Portland General Electric Company**  
Portland, Oregon

### ENRON WIND CORP.

#### North America

Tehachapi, California

#### Europe

Alborg, Denmark  
Athens, Greece  
London, United Kingdom  
Madrid, Spain  
Salzbergen, Germany  
Stockholm, Sweden

*ROBERT A. BELFER* <sup>(1,3)</sup>  
New York, New York  
Chairman, Belco Oil & Gas Corp.

*NORMAN P. BLAKE, JR.* <sup>(3,4)</sup>  
Memphis, Tennessee  
CEO and Secretary General, United States  
Olympic Committee, and Former Chairman,  
President and CEO, Promus Hotel Corporation

*RONNIE C. CHAN* <sup>(2,3)</sup>  
Hong Kong  
Chairman, Hang Lung Development  
Company Limited

*JOHN H. DUNCAN* <sup>(1,4)</sup>  
Houston, Texas  
Former Chairman of the Executive Committee  
of Gulf & Western Industries, Inc.

*JOE H. FOY* <sup>(1,2)</sup>  
Houston, Texas  
Retired Senior Partner, Bracewell & Patterson,  
and Former President and COO, Houston  
Natural Gas Corp.

*WENDY L. GRAMM* <sup>(2,5)</sup>  
Washington, D.C.  
Former Chairman, U.S. Commodity Futures  
Trading Commission

*KEN L. HARRISON*  
Portland, Oregon  
Former Chairman and CEO, Portland General  
Electric Company

*ROBERT K. JAEDICKE* <sup>(2,4)</sup>  
Stanford, California  
Professor of Accounting (Emeritus) and  
Former Dean, Graduate School of Business,  
Stanford University

*KENNETH L. LAY* <sup>(1)</sup>  
Houston, Texas  
Chairman and CEO, Enron Corp.

*CHARLES A. LEMAISTRE* <sup>(1,4)</sup>  
San Antonio, Texas  
President Emeritus, University of Texas  
M.D. Anderson Cancer Center

# BOARD OF DIRECTORS



**REBECCA MARK-JUSBASCHE**  
Houston, Texas  
Chairman and CEO, Azurix Corp.

**JOHN MENDELSON** <sup>(2, 5)</sup>  
Houston, Texas  
President, University of Texas  
M.D. Anderson Cancer Center

**JEROME J. MEYER** <sup>(3, 5)</sup>  
Wilsonville, Oregon  
Chairman, Tektronix, Inc.

**PAULO V. FERRAZ PEREIRA** <sup>(2, 3)</sup>  
Rio de Janeiro, Brazil  
President and CEO, Meriodinal Financial Group,  
and Former President and CEO,  
State Bank of Rio de Janeiro, Brazil

**FRANK SAVAGE** <sup>(3, 4)</sup>  
Stamford, Connecticut  
Chairman, Alliance Capital Management  
International (a division of Alliance Capital  
Management L.P.)

**JEFFREY K. SKILLING** <sup>(1)</sup>  
Houston, Texas  
President and COO, Enron Corp.

**JOHN A. URQUHART** <sup>(3)</sup>  
Fairfield, Connecticut  
Senior Advisor to the Chairman, Enron Corp.,  
President, John A. Urquhart Associates, and  
Former Senior Vice President of Industrial and  
Power Systems, General Electric Company

**JOHN WAKEHAM** <sup>(2, 5\*)</sup>  
London, England  
Former U.K. Secretary of State for Energy and  
Leader of the Houses of Lords and Commons

**HERBERT S. WINOKUR, JR.** <sup>(1, 3\*)</sup>  
Greenwich, Connecticut  
Chairman and CEO, Capricorn Holdings, Inc.,  
and Former Senior Executive Vice President,  
Penn Central Corporation

- <sup>(1)</sup> Executive Committee
- <sup>(2)</sup> Audit Committee
- <sup>(3)</sup> Finance Committee
- <sup>(4)</sup> Compensation Committee
- <sup>(5)</sup> Nominating Committee
- \* Denotes Chairman

*FROM LEFT TO RIGHT: Charles A. LeMaistre, Ronnie C. Chan, Herbert S. Winokur, Jr., Paulo V. Ferraz Pereira, Kenneth L. Lay, Jeffrey K. Skilling, Norman P. Blake, Jr., Wendy L. Gramm, John Mendelsohn, Robert A. Belfer, John Wakeham, Robert K. Jaedicke, John H. Duncan, Joe H. Foy, Ken L. Harrison, Jerome J. Meyer, Rebecca Mark-Jusbasche, Frank Savage and John A. Urquhart.*

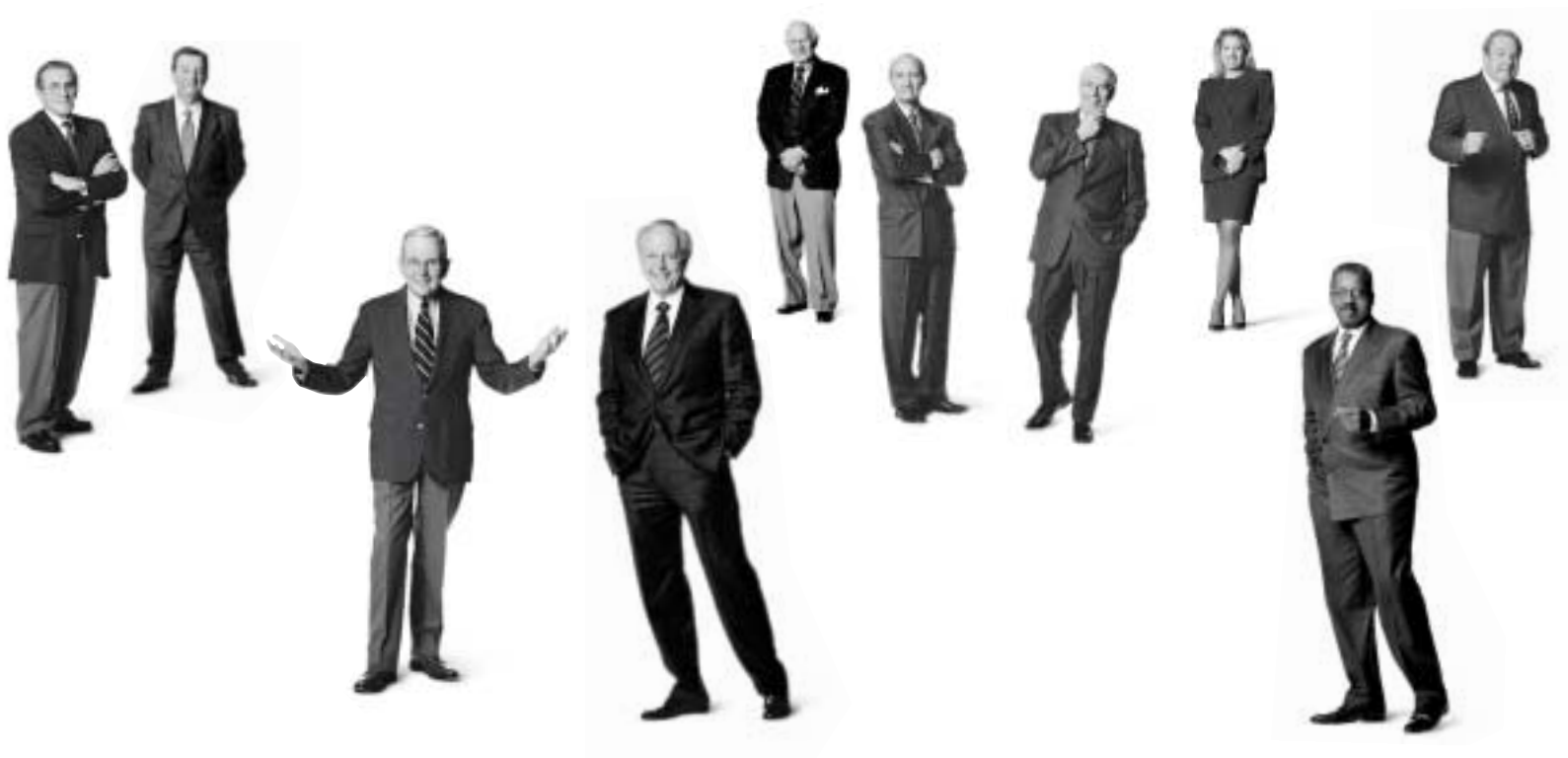

## ENRON EXECUTIVE COMMITTEE

### **JIM BANNANTINE**

Co-Chairman & Chief Executive Officer, Enron South America

### **CLIFF BAXTER**

Chairman & Chief Executive Officer, Enron North America

### **SANJAY BHATNAGAR**

Chief Executive Officer, Enron India

### **RICK BUY**

Executive Vice President & Chief Risk Officer, Enron Corp.

### **RICK CAUSEY**

Executive Vice President & Chief Accounting Officer, Enron Corp.

### **DIOMEDES CHRISTODOULOU**

Co-Chairman & Chief Executive Officer, Enron South America

### **JIM DERRICK**

Executive Vice President & General Counsel, Enron Corp.

### **ANDY FASTOW**

Executive Vice President & Chief Financial Officer, Enron Corp.

### **PEGGY FOWLER**

President, Portland General Electric Company

### **MARK FREVERT**

Chairman & Chief Executive Officer, Enron Europe, Ltd.

### **KEVIN HANNON**

Chief Operating Officer, Enron Broadband Services

### **KEN HARRISON**

Chief Executive Officer, Portland General Electric Company

### **DAVID HAUG**

Chairman & Chief Executive Officer, Enron Caribbean, Enron Middle East, Enron Global LNG

### **JOE HIRKO**

Chief Executive Officer, Enron Broadband Services

### **STAN HORTON**

Chairman & Chief Executive Officer, Enron Gas Pipeline Group

### **KURT HUNEKE**

Chief Executive Officer, Global Asset Operations, Enron Corp.

### **LARRY IZZO**

President & Chief Executive Officer, Enron Engineering & Construction Company

### **STEVE KEAN**

Executive Vice President & Chief of Staff, Enron Corp.

### **MARK KOENIG**

Executive Vice President, Investor Relations, Enron Corp.

### **KEN LAY**

Chief Executive Officer & Chairman of the Board, Enron Corp.

### **REBECCA MARK-JUSBASCHE**

Chairman & Chief Executive Officer, Azurix Corp.

### **MIKE MCCONNELL**

Chief Executive Officer, Global Technology, Enron Corp.

### **REBECCA MCDONALD**

Chairman & Chief Executive Officer, Enron Asia Pacific, Africa & China

### **JEFF MCMAHON**

Executive Vice President, Finance and Treasurer, Enron Corp.

### **MARK METTS**

Executive Vice President, Corporate Development, Enron Corp.

### **CINDY OLSON**

Executive Vice President, Human Resources & Community Relations, Enron Corp.

### **LOU PAI**

Chairman & Chief Executive Officer, Enron Energy Services, LLC

### **KEN RICE**

Chief Commercial Officer, Enron Broadband Services

### **JEFF SHERRICK**

President & Chief Executive Officer, Enron Global Exploration & Production

### **JOHN SHERRIFF**

President, Enron Europe, Ltd.

### **JEFF SKILLING**

President & Chief Operating Officer, Enron Corp.

### **JOE SUTTON**

Vice Chairman, Enron Corp.

### **GREG WHALLEY**

President & Chief Operating Officer, Enron North America

### **TOM WHITE**

Vice Chairman, Enron Energy Services, LLC

## SHAREHOLDER INFORMATION

### **TRANSFER AGENT, REGISTRAR, DIVIDEND PAYING AND REINVESTMENT PLAN AGENT (DIRECTSERVICE PROGRAM)**

First Chicago Trust Company, a division of EquiServe  
P.O. Box 2500  
Jersey City, NJ 07303-2500  
(800) 519-3111  
(201) 324-1225  
TDD: (201) 222-4955  
For direct deposit of dividends only, call:  
(800) 870-2340  
Internet address: <http://www.equiserve.com>

### **1999 ANNUAL REPORT**

This Annual Report and the statements contained herein are submitted for the general information of the shareholders of Enron Corp. and are not intended for use in connection with or to induce the sale or purchase of securities.

### **ADDITIONAL INFORMATION**

Enron Corp.'s Annual Report to shareholders and Form 10-K report to the Securities and Exchange Commission are available upon request on Enron's Internet address <http://www.enron.com>  
For information regarding specific shareholder questions, write or call the Transfer Agent.

Financial analysts and investors who need additional information should contact:  
Enron Corp.  
Investor Relations Dept.  
P.O. Box 1188, Suite 4926B  
Houston, TX 77251-1188  
(713) 853-3956  
Enron's Internet address: <http://www.enron.com>

### **ANNUAL MEETING OF SHAREHOLDERS**

The Annual Meeting of Shareholders will be held in Houston, Texas, in the LaSalle Ballroom of the Doubletree Hotel at Allen Center, 400 Dallas Street, on Tuesday, May 2, 2000, at 10 a.m. Information with respect to this meeting is contained in the Proxy Statement sent with this Annual Report to holders of record of Enron Corp.'s Common Stock and the Cumulative Second Preferred Convertible Stock on March 3, 2000. The 1999 Annual Report is not to be considered a part of the proxy soliciting material.

### **DIVIDEND REINVESTMENT**

The Transfer Agent offers holders of Enron Corp. Common Stock the opportunity to reinvest part or all of their dividends in the purchase of additional shares of Common Stock by participating in the DirectSERVICE Program for Shareholders of Enron Corp. This program gives almost everyone the opportunity to purchase additional shares of Common Stock without paying a brokerage commission. Anyone wishing to participate in the program may, upon timely application, reinvest some, all, or none of the cash dividends paid on their Common Stock, or make optional cash payments of as little as \$25, after an initial investment of \$250 for new shareholders, with a limit of \$120,000 per calendar year. Direct requests for further information to: DirectSERVICE Program for Shareholders of Enron Corp.  
c/o First Chicago Trust Company, a division of EquiServe  
P.O. Box 2598  
Jersey City, NJ 07303-2598  
Shareholders may call: (800) 519-3111  
Non-shareholders requests for program materials: (800) 662-7662  
Internet address: <http://www.equiserve.com>  
TDD: (201) 222-4955



# OUR VALUES

## *COMMUNICATION*

We have an obligation to communicate. Here, we take the time to talk with one another... and to listen. We believe that information is meant to move and that information moves people.

## *RESPECT*

We treat others as we would like to be treated ourselves. We do not tolerate abusive or disrespectful treatment. Ruthlessness, callousness and arrogance don't belong here.

## *INTEGRITY*

We work with customers and prospects openly, honestly and sincerely. When we say we will do something, we will do it; when we say we cannot or will not do something, then we won't do it.

## *EXCELLENCE*

We are satisfied with nothing less than the very best in everything we do. We will continue to raise the bar for everyone. The great fun here will be for all of us to discover just how good we can really be.



**Endless possibilities.™**

1400 Smith Street  
Houston, Texas 77002-7361  
[www.enron.com](http://www.enron.com)

©2000 Enron Corp. Enron and the Enron logo are registered trademarks and Endless possibilities, ePowered, ePowered Media Cast, ePowered Media Transport and EnronOnline are trademarks of Enron Corp. or one of its subsidiaries. Other company, product and service names may be trademarks of others.